

Bicycle Lafayette

Master Plan Document
Lafayette, Louisiana
2022.06.20 V1



Bicycle Lafayette

Master Plan Document
Lafayette, Louisiana
2022.06.20 V1

Team

Architect

SO Studio

sostudioarchitecture.com
 Stephen Ortego, AIA
 Audrey Presnell, Assoc. AIA
 Nouf AlBalushi, Assoc. AIA

Landscape Architect

Carbo Landscape Architects

carbo-la.com
 Shannon Blakeman, PLA, ASLA
 Conner Howard, ASLA
 John-Tayler Corley, ASLA

Graphic Designer

Makemade

makemade.com
 Peter DeHart
 Allison Bohl DeHart
 Camille Broussard

Traffic Engineer

Dean Tekall Consulting

trafficstudy.com
 Dean Tekall, PE, PTOE

Civil Engineer

Southeast Engineers

reengineers.com
 James J. Ricks, PE

Table of Contents

1. Overview	7	7. Signaling at Intersections	163
1.1 Location and Climate	8	7.1 Intersection Signals	164
1.2 Why?	10	7.2 Bicycle Phasing	166
1.3 Route Lafayette	12		
1.4 Project Goals	14	8. Trailheads	173
1.5 Methodology	16	8.1 Trailhead Locations	174
		8.2 Trailhead Typologies	176
2. Map Diagrams	19	8.3 Trailhead Amenities	178
2.1 Mappings	20		
		9. Wayfinding	179
3. Public Participation	39	9.1 Wayfinding Overview	180
3.1 Experts Charrette	40	9.2 Colors and Patterns	182
3.2 Community Meeting	42	9.3 Arrows and Typology	186
3.3 Public Questionnaire	46	9.4 Sign Family	188
		9.5 Trail Maps	198
4. Proposed Network	57	9.6 Pavement Markings	202
4.1 Connection	58	9.7 Design Details	204
4.2 Network Map	60		
4.3 Phase 1: Get in the Loop	64	Works Cited	214
5. Route Diagrams	93		
5.1 Route Linear Diagrams	94		
5.2 Route Sectional Diagrams	110		
6. Street Design	123		
6.1 Street Typologies	124		
6.2 Bicycle Paths at Bus Stops	142		
6.3 Curb Details	144		
6.4 Rainwater Management	146		
6.5 Intersection Typologies	148		



1

Overview

The Bicycle Lafayette Master Plan document presents a plan and strategies to build a connected, safe, comfortable and equitable bicycle system. The document aims to demonstrate data and public input, bicycle network design, street design, trailhead design, and wayfinding elements for a complete and comprehensive system.

- 1.1 Location and Climate
- 1.2 Why?
- 1.3 Route Lafayette
- 1.4 Project Goals
- 1.5 Methodology

1.1 Location and Climate

Lafayette is in southern Louisiana within the heart of the Acadiana region. Known as one of the Happiest Cities in America, the City of Lafayette possesses a unique culture and mix of people most notable for its Cajun-Creole identity. As the city continues to grow, considerations for alternative modes of transportation have become an essential topic of discussion. Lafayette is well suited for the incorporation of a robust bicycle route system. With its relatively mild weather, the climate is conducive to year-round bicycling. Although the weather in Lafayette is favorable, there are climatic conditions to consider when designing bicycle infrastructure. The summers here are hot and humid. Because of this, shade is a critical commodity for any outdoor activity. Stormwater management has become increasingly important and will continue to be a chief aspect that needs further consideration. The plan provided in this document takes these significant factors into account.

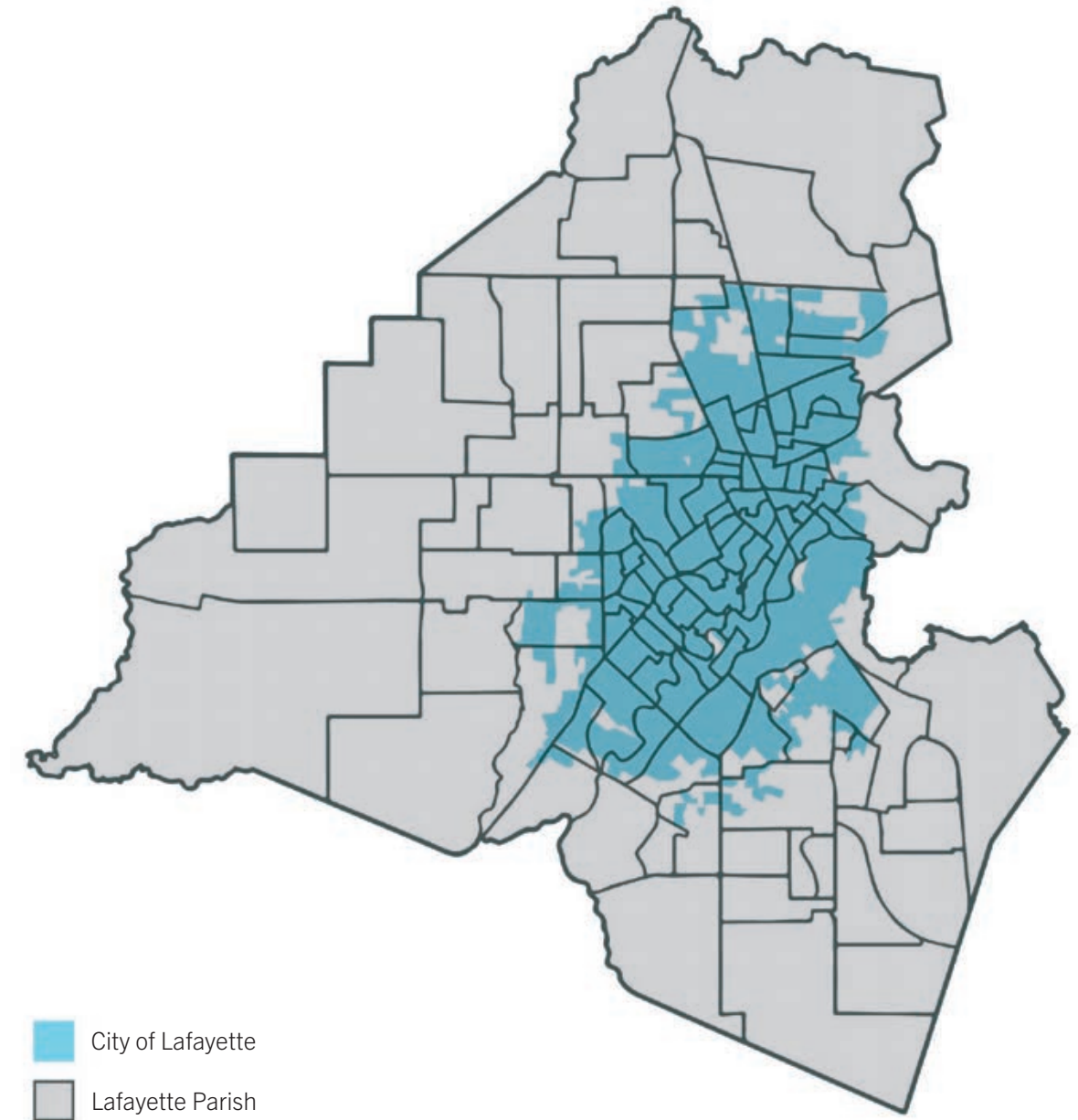

1.2 Why?

1.2.1 Need for bicycle infrastructure

Lafayette, like many cities today, has experienced pockets of uneven development with varying levels of complexity and incompleteness. This uneven development has left the city with disparities in opportunities and ultimately social inequalities. What makes cities so resilient and innovative is the result of spontaneous integration through density and diversity (Clos). This spontaneous integration is undermined by a fragmented community. In analyzing data collected while creating the Bicycle Lafayette Plan this fragmentation becomes most obvious in looking at poverty rates and car ownership rates by census tract.

By stitching together the fragmented community through bicycle infrastructure, a much easier obtained mode of transportation than automobiles, the city becomes a space for a more equitable urban environment with upward mobility for often left behind communities. With the overlapping complexities, convergent issues can be confronted or even resolved. The most obvious social divider for decades has been the Evangeline Throughway and even before

this, the railroad as seen in [Chapter 3](#) (Mader, 2022).

The Bicycle Lafayette Plan confronts, with the hope of resolving, this disequilibrium. It is best seen through the linear diagrams in [Chapter 5](#) where areas of high poverty rates and low car ownership rates are connected along the proposed routes. Also wealthy areas suffer from the disequilibrium and the community as a whole suffers. The hope is that Lafayette's citizens discover areas of their own city with great richness of culture, historic building stock, and diversity of natural landscapes that have been previously overlooked.

When our team first began the planning process we approached the design as categorizing commuter (or urban) routes and recreational trails. It became apparent that these categories would constrain the design. The proposed routes, and their street designs of the Bicycle Lafayette Plan blur the line between a commuter bike route and a recreational bike trail. While receiving public input, it became evident that the more separated from the roadway a bike path was, the more popular the typical street section (See [Chapter 3](#)).

Commute as recreation is not only improving our quality of life but also becomes an economic development tool. Access

to quality jobs becomes more tenable with multimodal transportation infrastructure. Improved health outcomes are another byproduct of better bicycle infrastructure (Götschi, 2016).

1.2.2 Need for a paradigm shift

We are confronted with a new situation with technology: phone software such as ride share and delivery apps are moving us towards a new paradigm for urban transportation. Quality of life has become more important in this age of urban nomads. The younger generation, exacerbated by the COVID 19 pandemic and communication advances, have the increasing ability to choose where to live and work more easily. (Florida, 2019) This creates an even more important



roll for multimodal transportation infrastructure.

In the past, people followed employment, now employment is following people and young talent is moving to areas that have higher qualities of life (Studer, 2021).

Extreme weather events and major flood events have also exacerbated the need for innovative rainwater management solutions. Space is not only needed for multimodal transportation but also for rainwater management opportunities.

1.2.3 Need for a plan

A master plan adds value through a cohesive design that accomplishes the goals. A bicycle system with equitability, safety, and comfortability creates a system that is used. If the system is not used it becomes a waste of public resources and a missed opportunity for the city and its citizens and visitors. The plan aims to better meet the goals of Bicycle Lafayette by using data and public input to inform design solutions.

A well informed system design shapes cities to be more resilient through design and ensures the city is more equitable and inclusive of all regardless of socio-economic backgrounds.

1.3 Route Lafayette

Bicycle Lafayette was born out of a previous project, Route Lafayette. In early 2020, Lafayette Consolidated Government in conjunction with the Downtown Development Authority (DDA) and Evangeline Corridor Initiative (ECI) engaged SO Studio, in conjunction with Makemade, to develop and implement this wayfinding system, later to be named Route Lafayette.

Route Lafayette is a bilingual (Louisiana French and English) wayfinding system based on the best practices of implementing an equitable wayfinding in urban areas and parks. Because Lafayette struggles to maintain its identity as home to a historic Cajun-Creole community, the system focuses on inclusion of the local Francophone vernacular. Louisiana French (the minority language) is the primary language of the system with English as secondary. The design approach is focused on walking, biking, and public transit with consideration for the visually impaired.

Route Lafayette was designed to influence the way people perceive their environment and positively transform the urban experience. The system was developed through a new paradigm that

adapted theories on city imagery from Kevin Lynch's *Image of the City* (1960) and used tests for insuring the inclusion of people with visual impairments. Lynch proposed that the imageability of the city can be categorized into paths, edges, districts, nodes, and landmarks. These categories were used to collect data from neighborhood focus groups, informing the locations of wayfinding totems (nodes), directions (pathways) as well as icons on totem maps (landmarks). The system points urban users towards public and institutional assets with an estimated time of travel rather than a distance. A secondary system helps guide users towards their destination when a turn is required. Bicycle Lafayette strives to expand upon this wayfinding system by changing the streets and paths themselves.



1.4 Project Goals

Create a bicycle network that is:

Safe

for pedestrians and bicyclists

Connected

through endings at other routes, traffic generators or regional assets

Comfortable

for ages 5 to 95 years old

Equitable

with accessibility for all demographics and minorities

New Standard

for bike infrastructure in the United States

Enjoyable

with a desirability to encourage use



Utrecht, Netherlands



Seattle, Washington



Eugene, Oregon



Fort Collins, Colorado

1.5 Methodology

1.5.1 Data Collection

Existing bike routes were analyzed along with bike and pedestrian crash data, floodways, waterways, walkability (walkscore), public and institutional lands, arterial roads and neighborhood boundaries (LCG). The team also analyzed existing right of way widths, automobile traffic counts, and the number of existing traffic lanes (LCG, DOTD). All of this data informed the design that was meant to connect neighborhoods with each other and to destinations such as work, shopping or recreation.

1.5.2 Preliminary Design

The Bicycle Lafayette network was developed by using data, particularly connecting of public and institutional assets, neighborhoods and parks with a reliance on traffic data, available right-of-way widths and potential cooperative endeavors with other public institutions in order to create needed links. Data collected that informed the design towards connectivity and equitability were poverty rates, car ownership rates

and identified neighborhoods. Walk score heat diagrams informed the design to areas that had concentrations of places that people work, shop or play (walkscore.com). Tree canopy coverage data was also taken into consideration and with the realization that shade in Louisiana extends the number of comfortable riding days for cyclists (treeequityscore.org).

The maps created from the data considerations are based on maps used for almost a century in public transit. This color coded route system has origins traced to Harry Beck and later popularized by Massimo Vignelli. This helps create a natural wayfinding system, orienting and encouraging the use of the bike routes (Kent, 2021). The routes also allow for further data analysis in testing the routes themselves for the goals of the project as well as analysis on typical sections along the route, taking into consideration of traffic counts to maintain automobile traffic capacities along the proposed routes (see page 37). In some cases, where not enough right-of-way was available to maintain this capacity and provide for separated bicycle paths and landscaping, routes were adjusted.

Public input, through public meetings and questionnaires, informed the community's desired typical street sections and

the need for separated bike paths from automobiles.

1.5.3 Master Plan

The main route that organizes the system is an almost nine mile loop. This loop connects seventeen neighborhoods and eleven city assets. The loop is bisected by a route that follows Coulee Saint John from Girard Park to Downtown at Congress Street. Many modes of transportation organize circulation around a loop and spoke system. Some notable loop and spoke systems are the trains in places like Tokyo, Berlin and Chicago. Most large North American cities have highway systems with this same organizing system as seen in cities such as

Atlanta, Houston and Dallas. Portland, OR is actually planning a “green loop” for bicycling in its urban core (City of Portland).

Each line was diagrammed for proposed typical street cross sections using available right-of-way. These sections were then modeled in axonometric diagrams and typical intersection organizations were developed. These street designs considered encouraging safer automobile traffic speeds, better practices in rainwater management strategies and increased shading as to decrease average temperatures. Details to these designs were then developed such as curb profiles, curb cuts, bioswales, overflow drains, and proposed typical infrastructure locations.

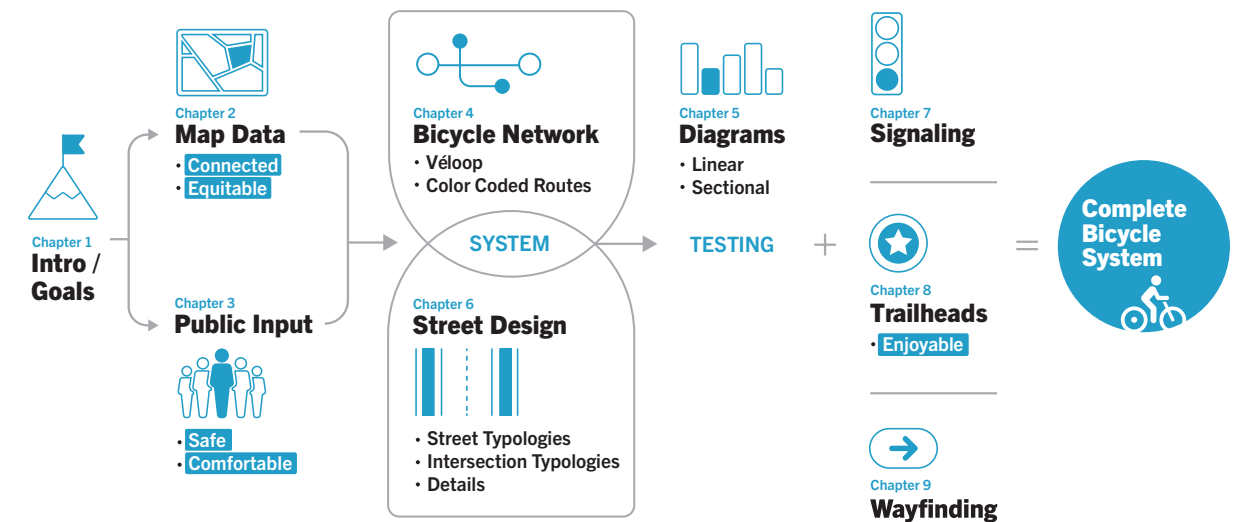

Bicycle Lafayette Master Plan Methodology

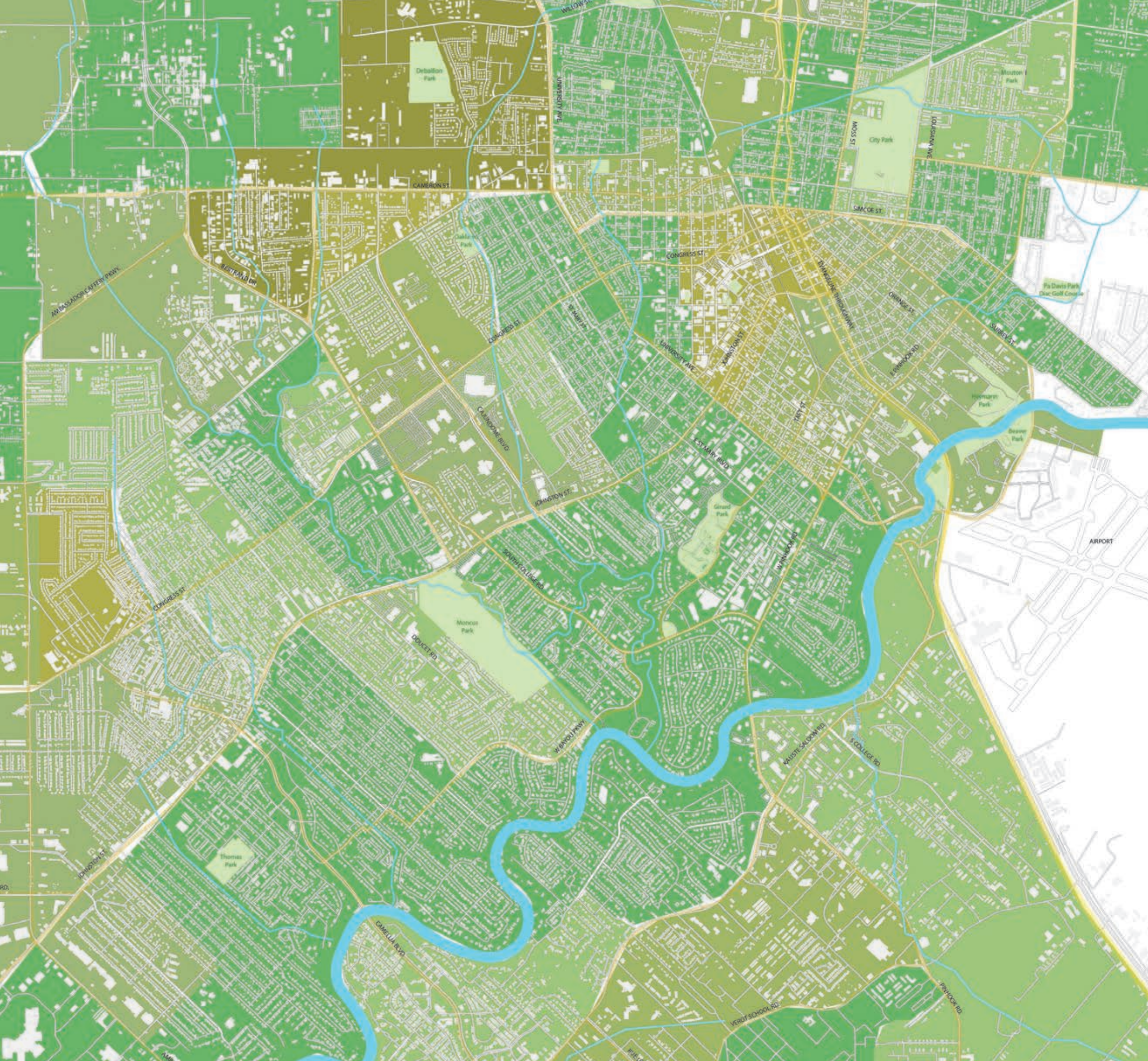

2

Map Diagrams

Data collected from various sources were diagrammed through a series of maps and layered on each other in order to inform design layouts for routes that would create the Bicycle Lafayette network. These inputs set out to inform where routes would be connected (walk score, public assets and neighborhoods), safe (crash data and roadway arterials), and equitable (poverty rates and car ownership), while maintaining automobile capacity at or above usage levels (traffic counts and number of travel lanes).

2.1 Mappings

2.1 Mappings

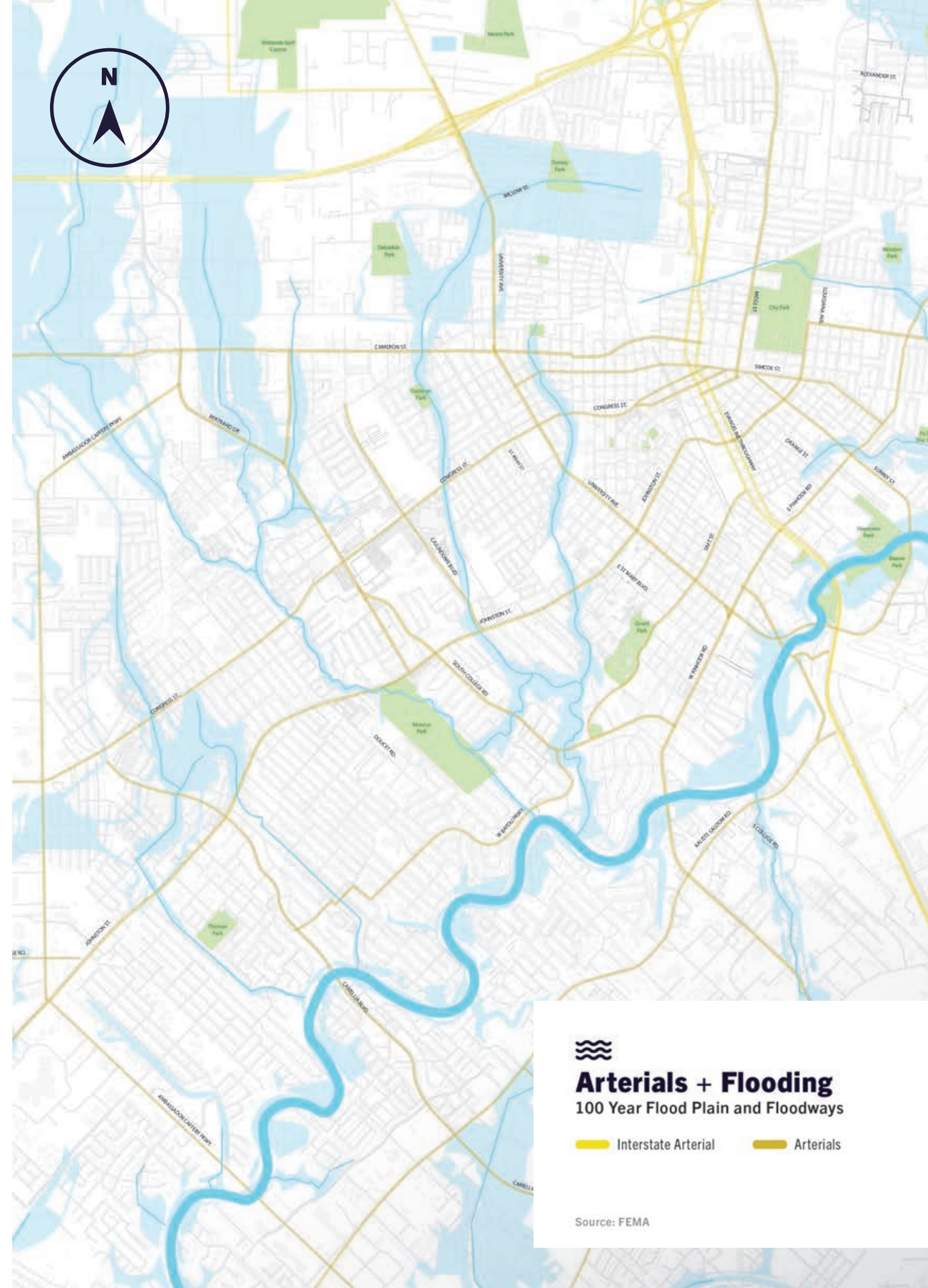



Existing Bike Routes

- Shared Roadway
- Bike Lane
- Separated Bike Lane
- Multi-use Path

Source: Lafayette Consolidated Government



Existing Trails

- Mardi Gras Parade Route
- Azalea Trail
- Atakapas-Ishak Trail
- Mickey's Loop

Source: Lafayette Consolidated Government, theadvocate.com

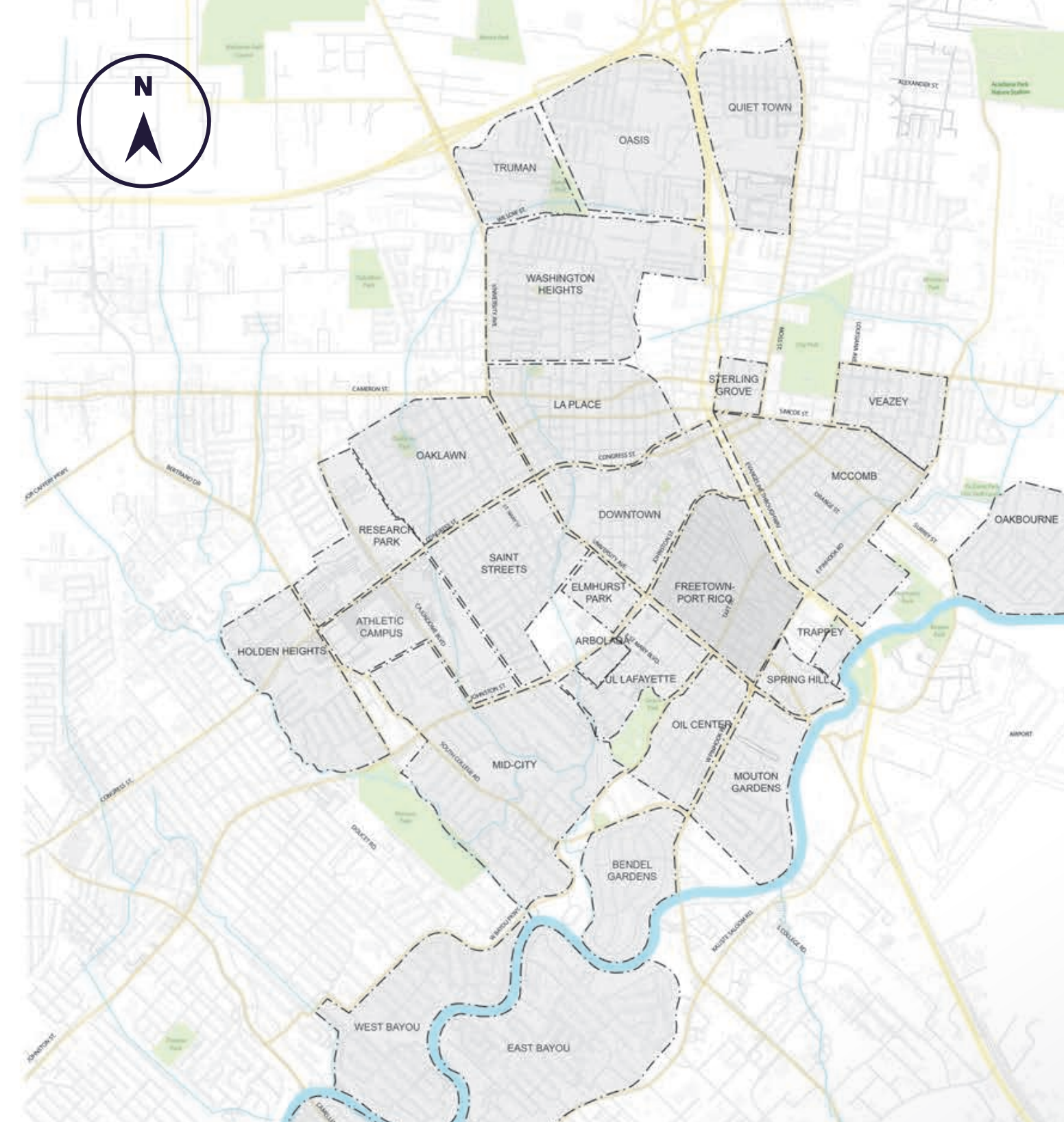
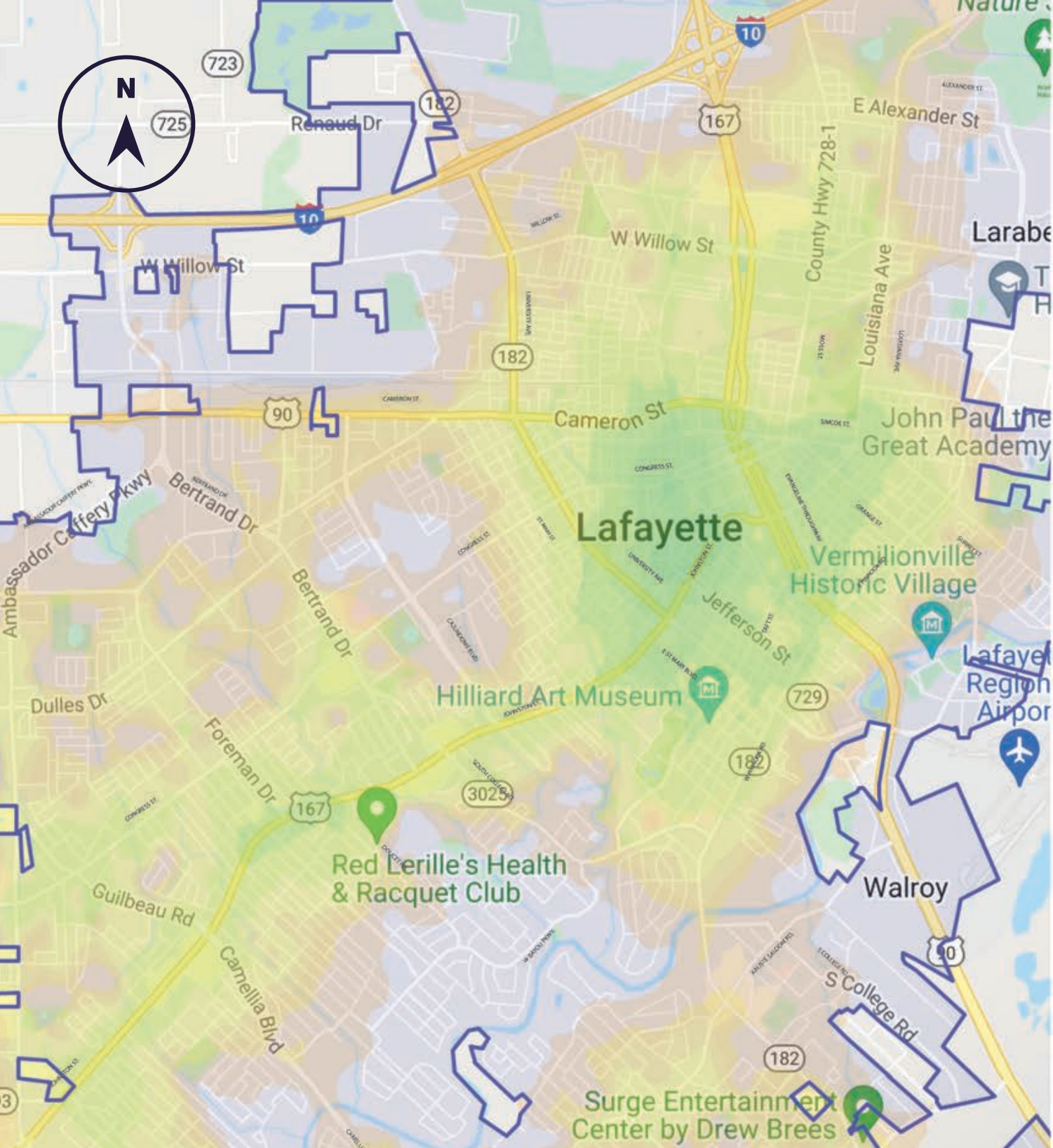

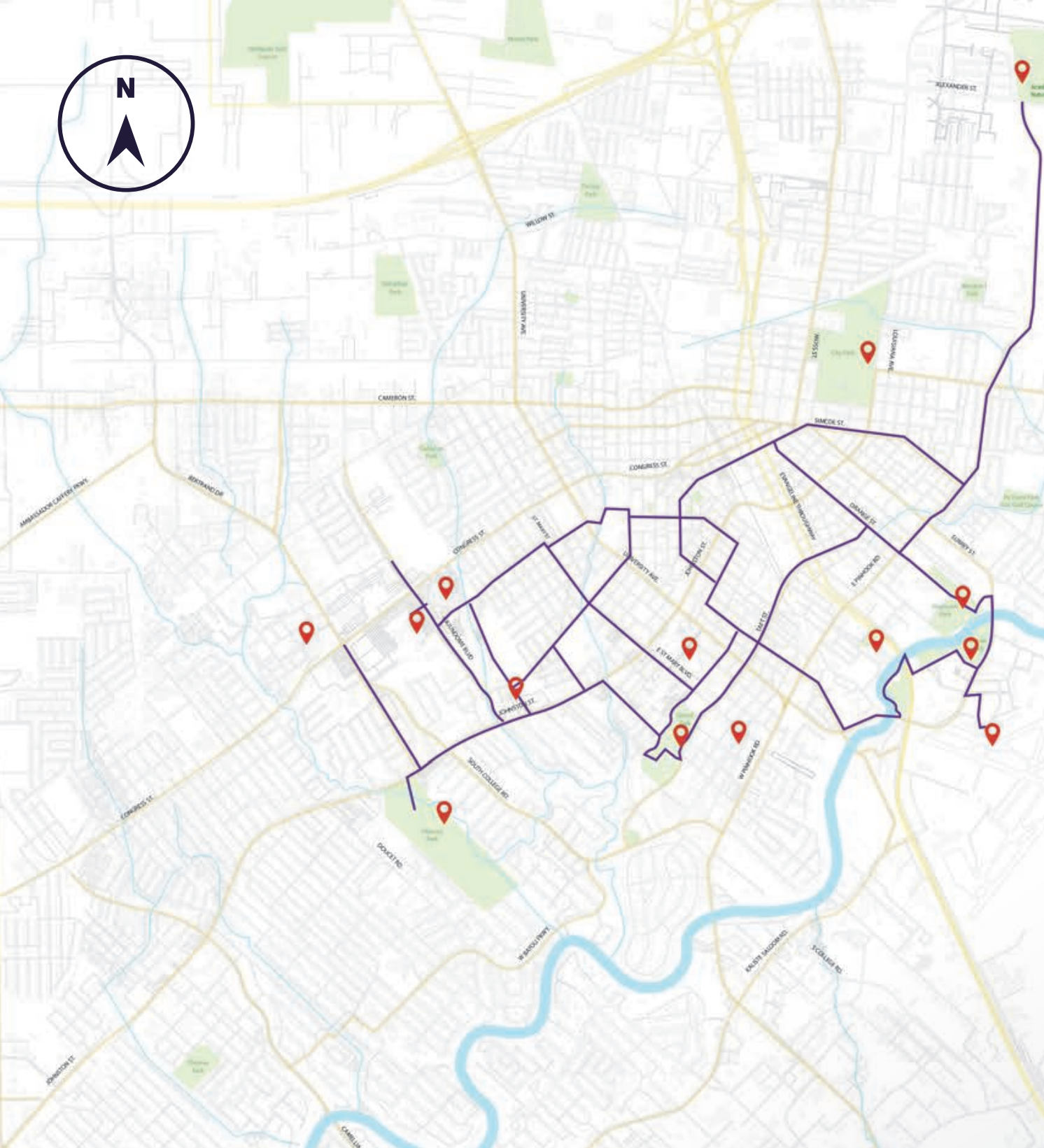

Public Assets + Route Lafayette



Regional Public Assets



Route Lafayette

Source: Lafayette Consolidated Government

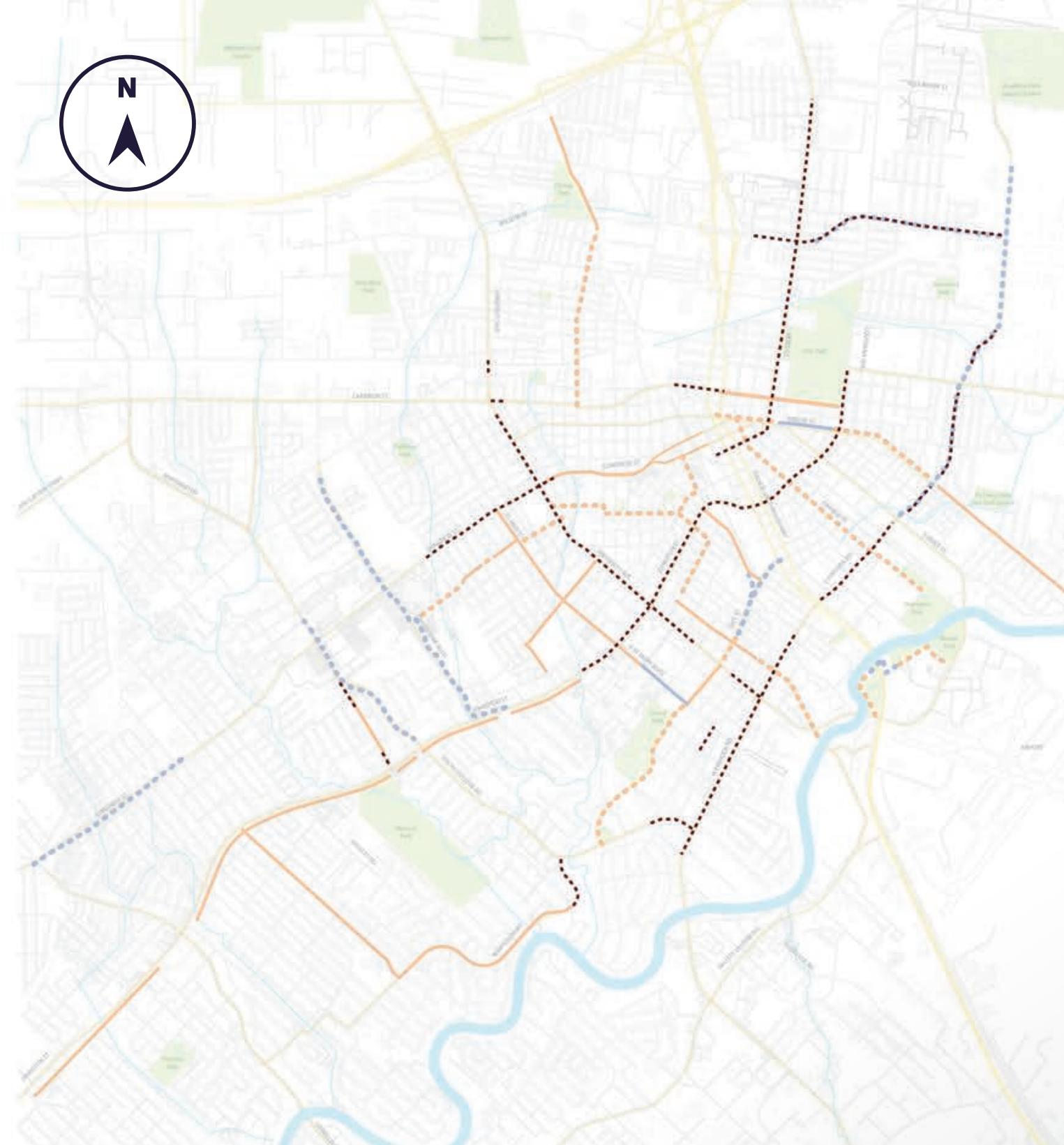

4 Lane Roads

4 Lane Roads

Shared Roadway

Bike Lane

Separated Bike Lane

Multi-use Path

Source: google.com/maps

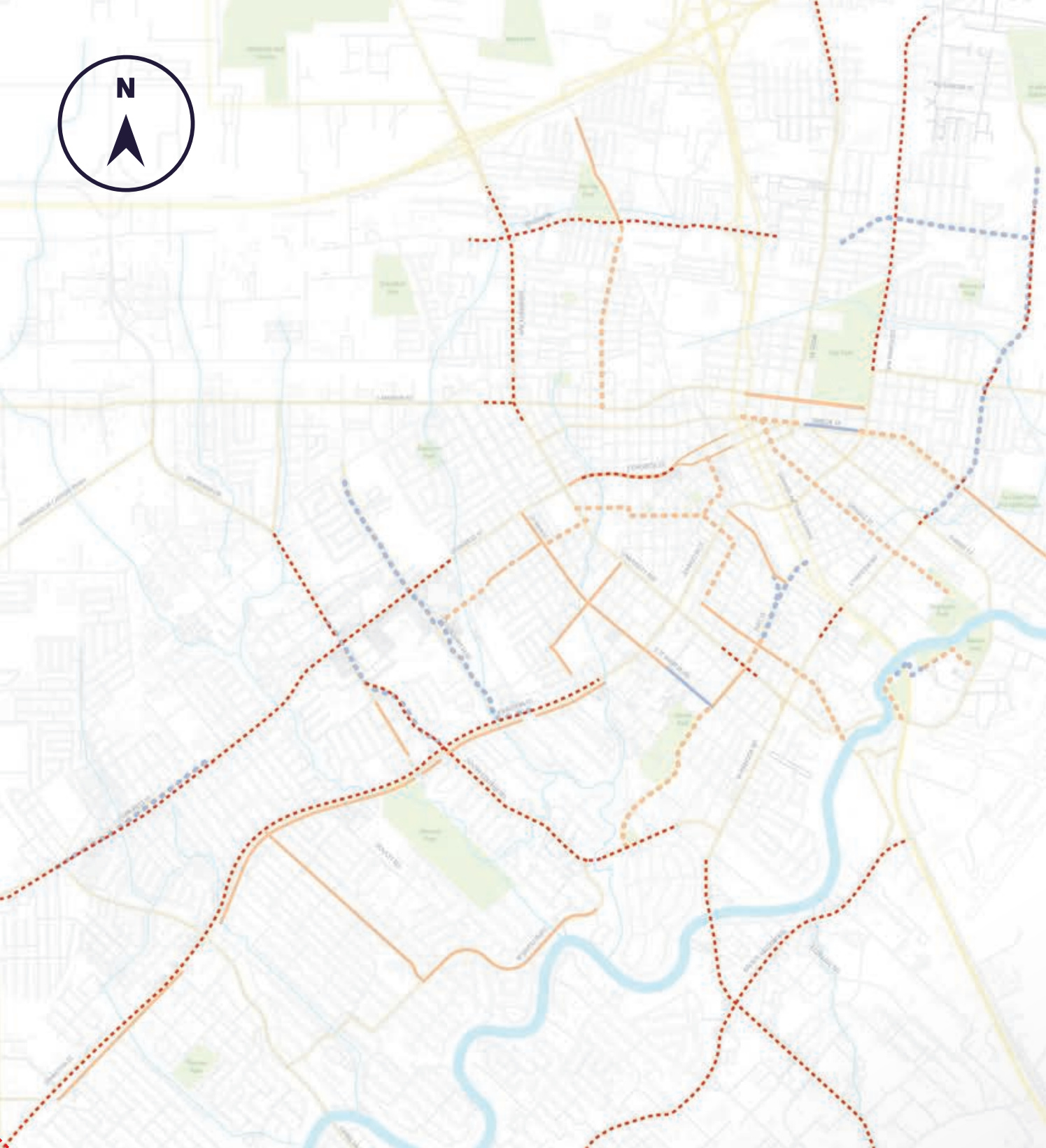

5 Lane Roads

- ⋯ 5 Lane Roads
- Shared Roadway
- Bike Lane
- Separated Bike Lane
- ⋯ Multi-use Path

Source: google.com/maps

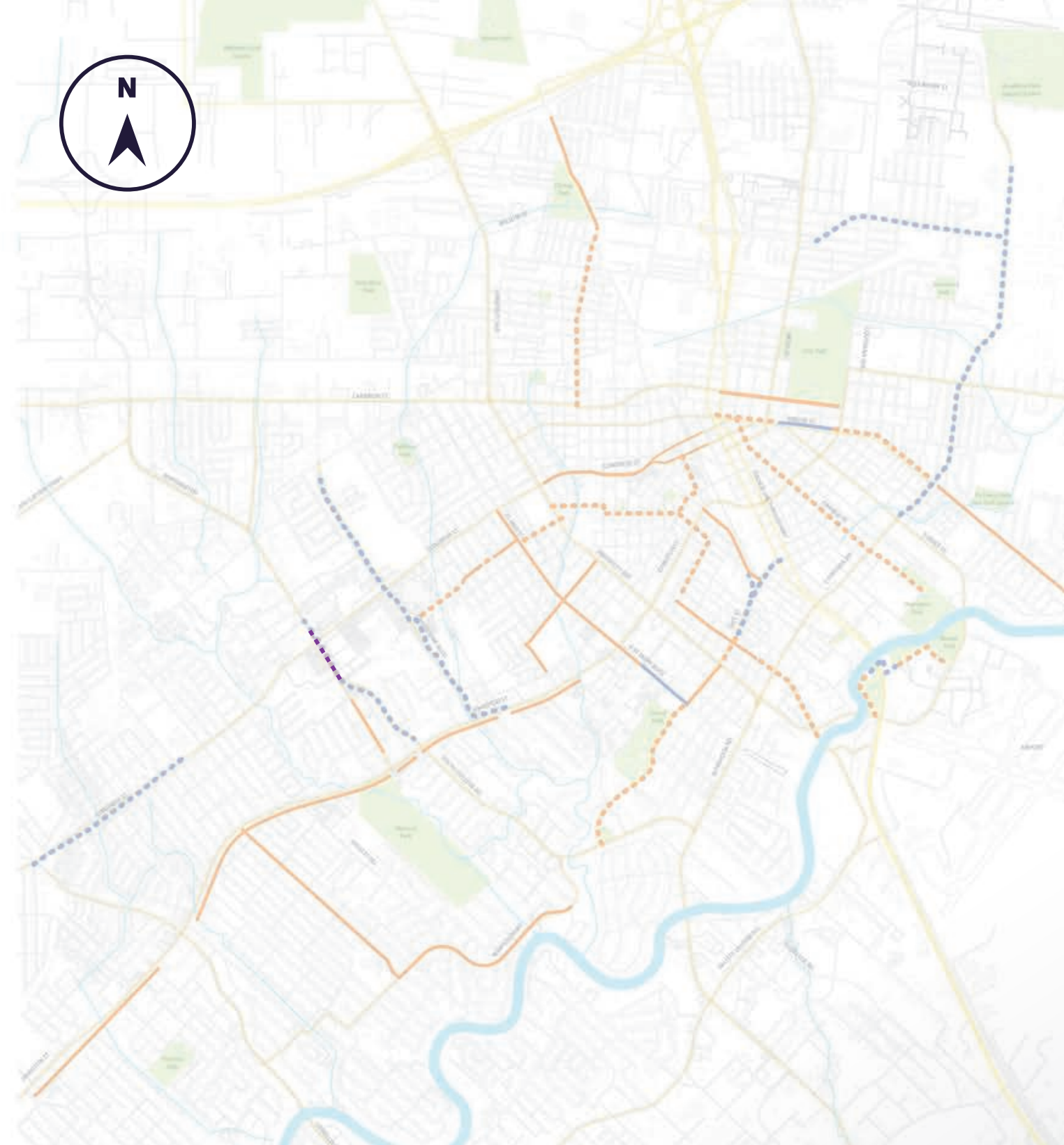

6 Lane Roads

- ⋯ 6 Lane Roads
- Shared Roadway
- Bike Lane
- Separated Bike Lane
- ⋯ Multi-use Path

Source: google.com/maps



Railroads + Waterways

- Active Railroad
- Abandoned Railroad
- Coulee
- Vermillion River

Source: Lafayette Consolidated Government

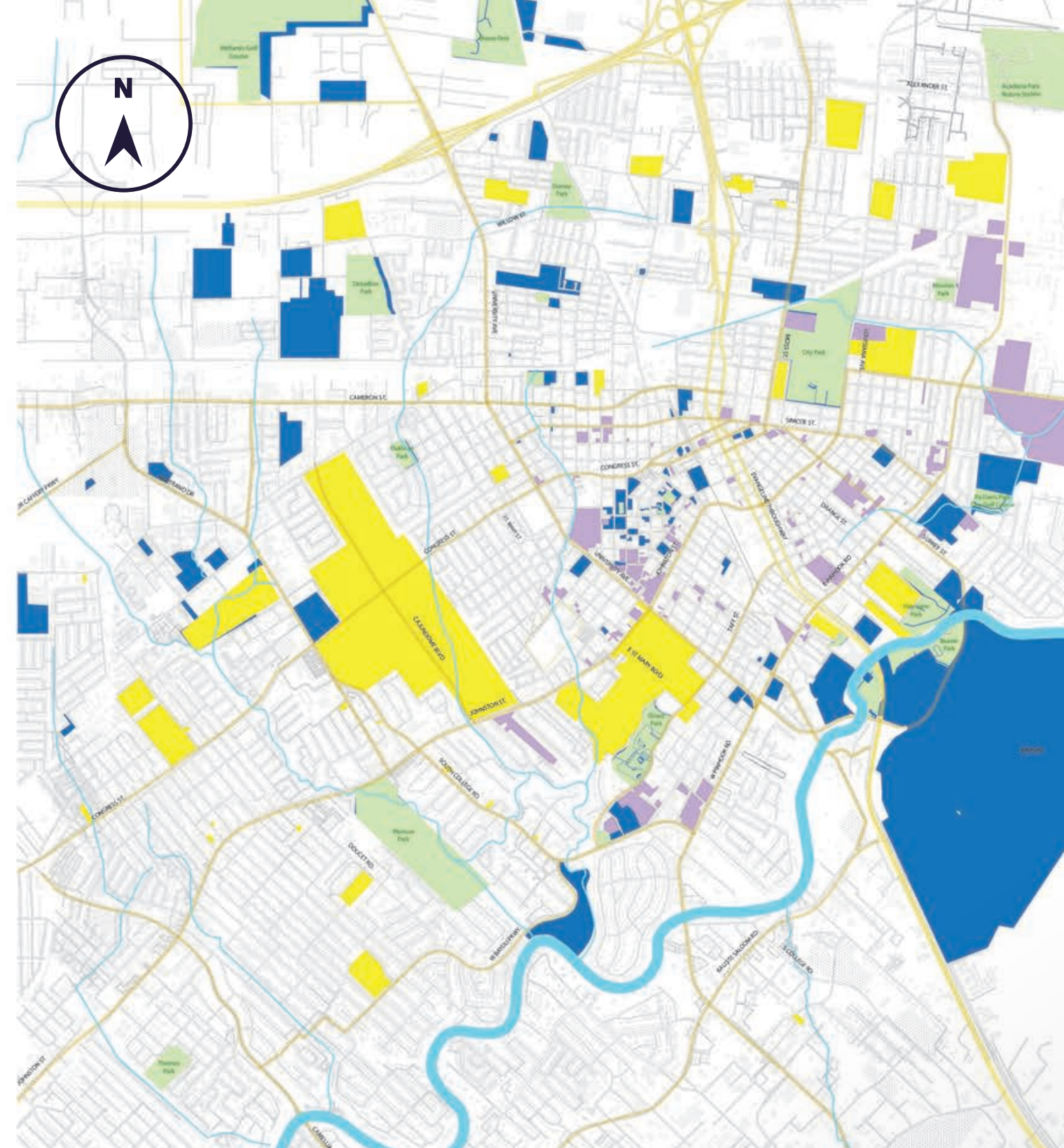

Public + Institutional Lands

- Public
- Institutional
- Educational
- Vacant Land

Source: Lafayette Consolidated Government

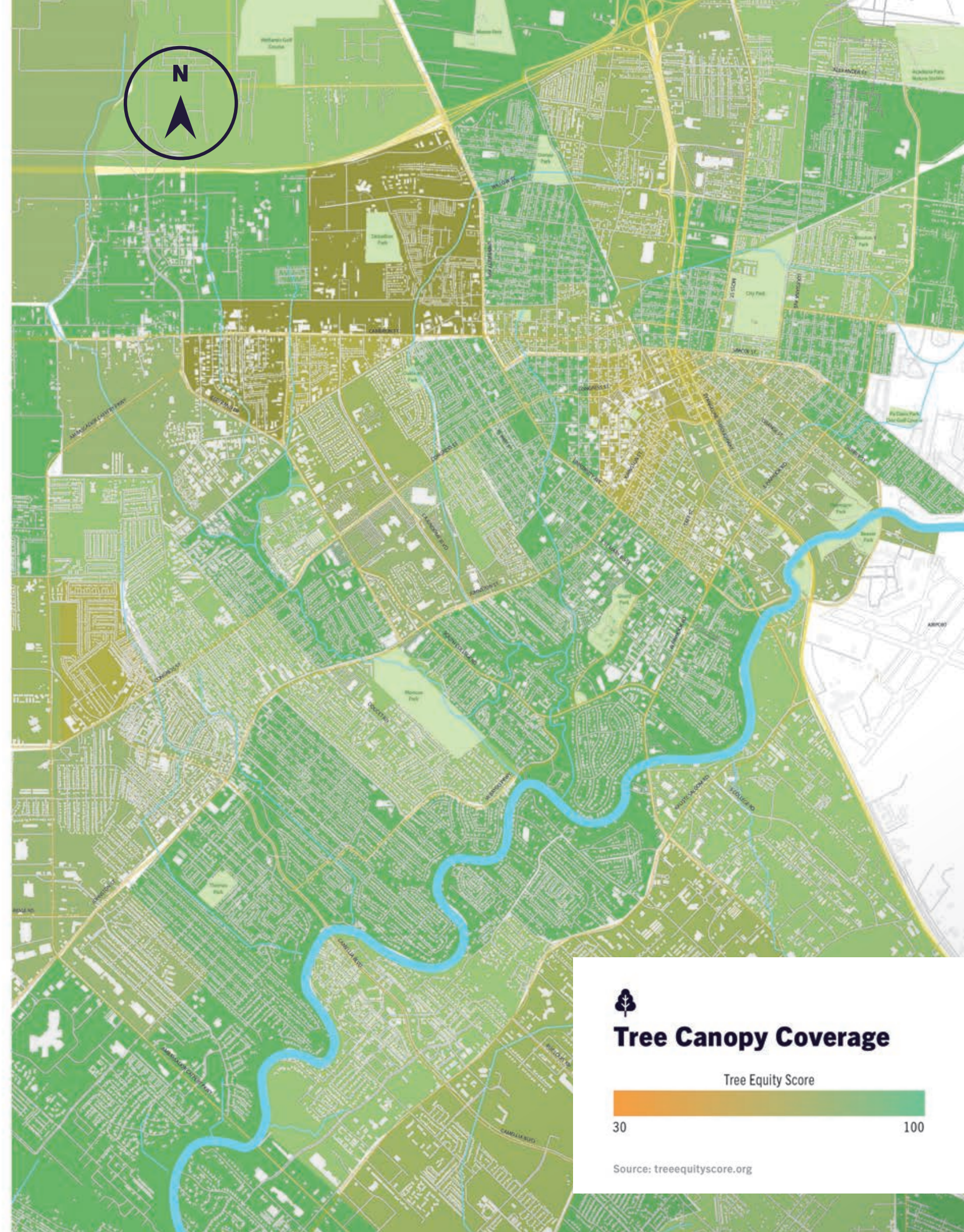
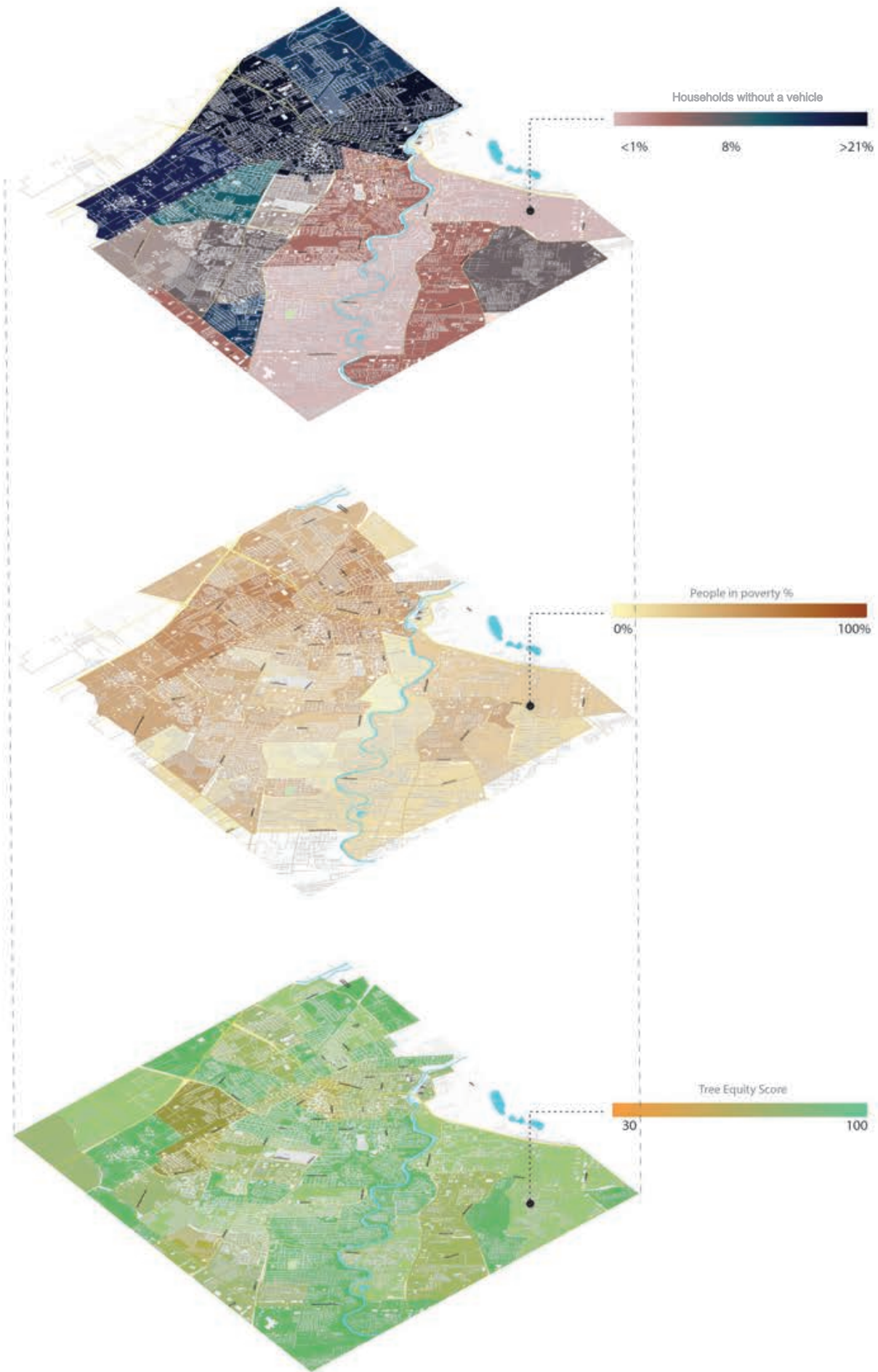

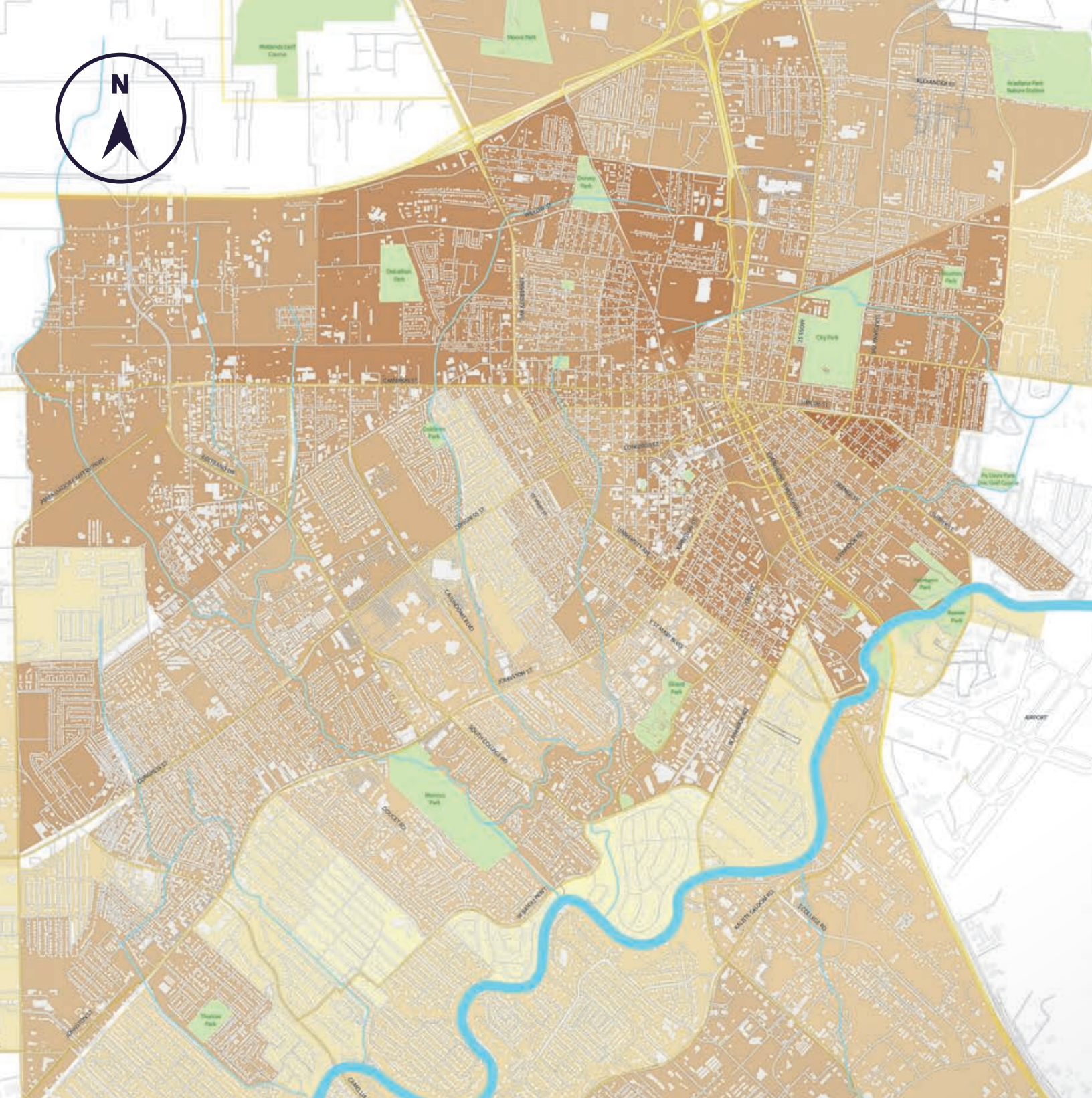

Poverty Rates

People in poverty %



0%

100%

Source: US Census Bureau

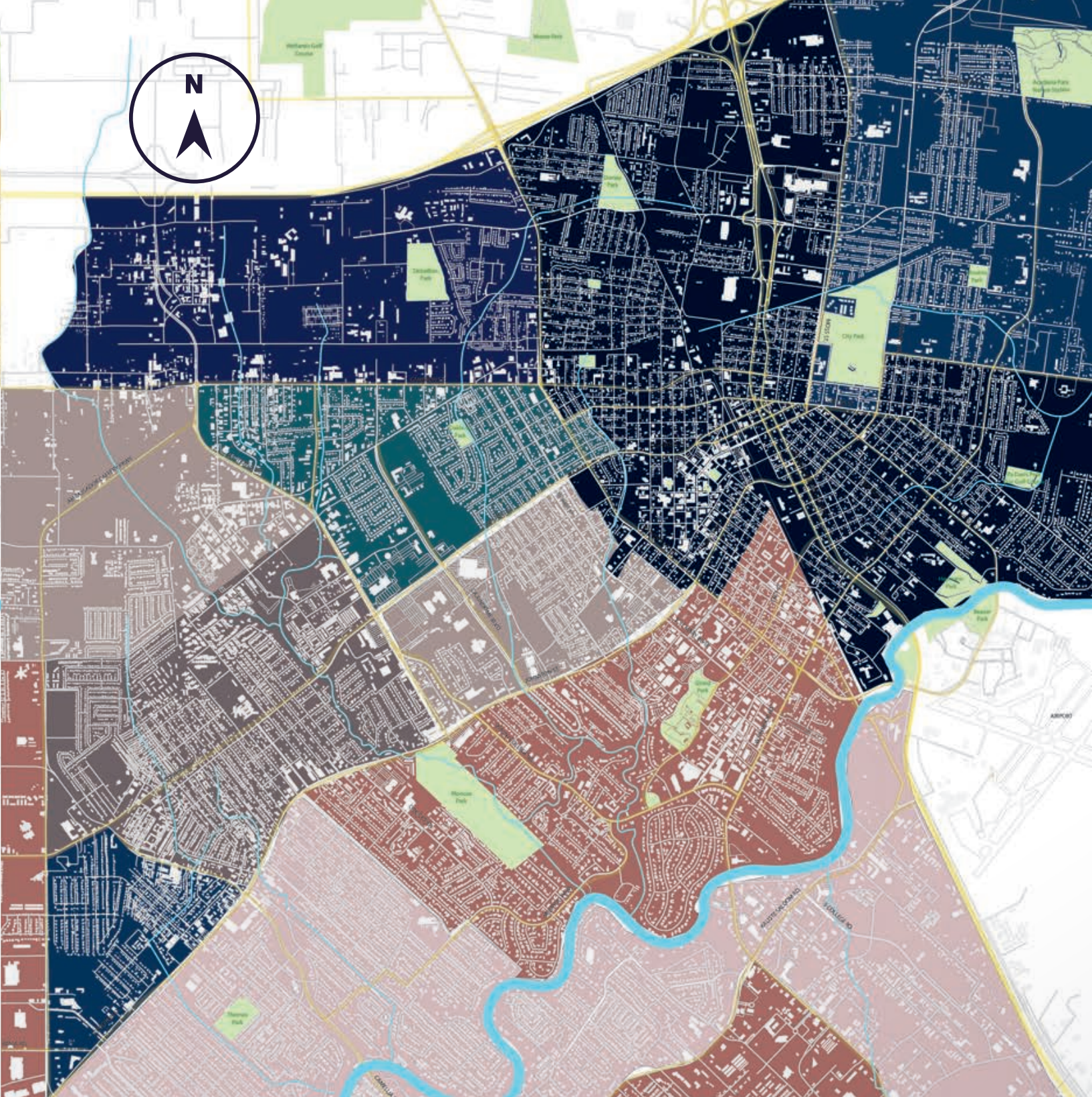

Car Ownership

% of households without a vehicle



>1%

9%
national figure

>21%

Source: US Census Bureau

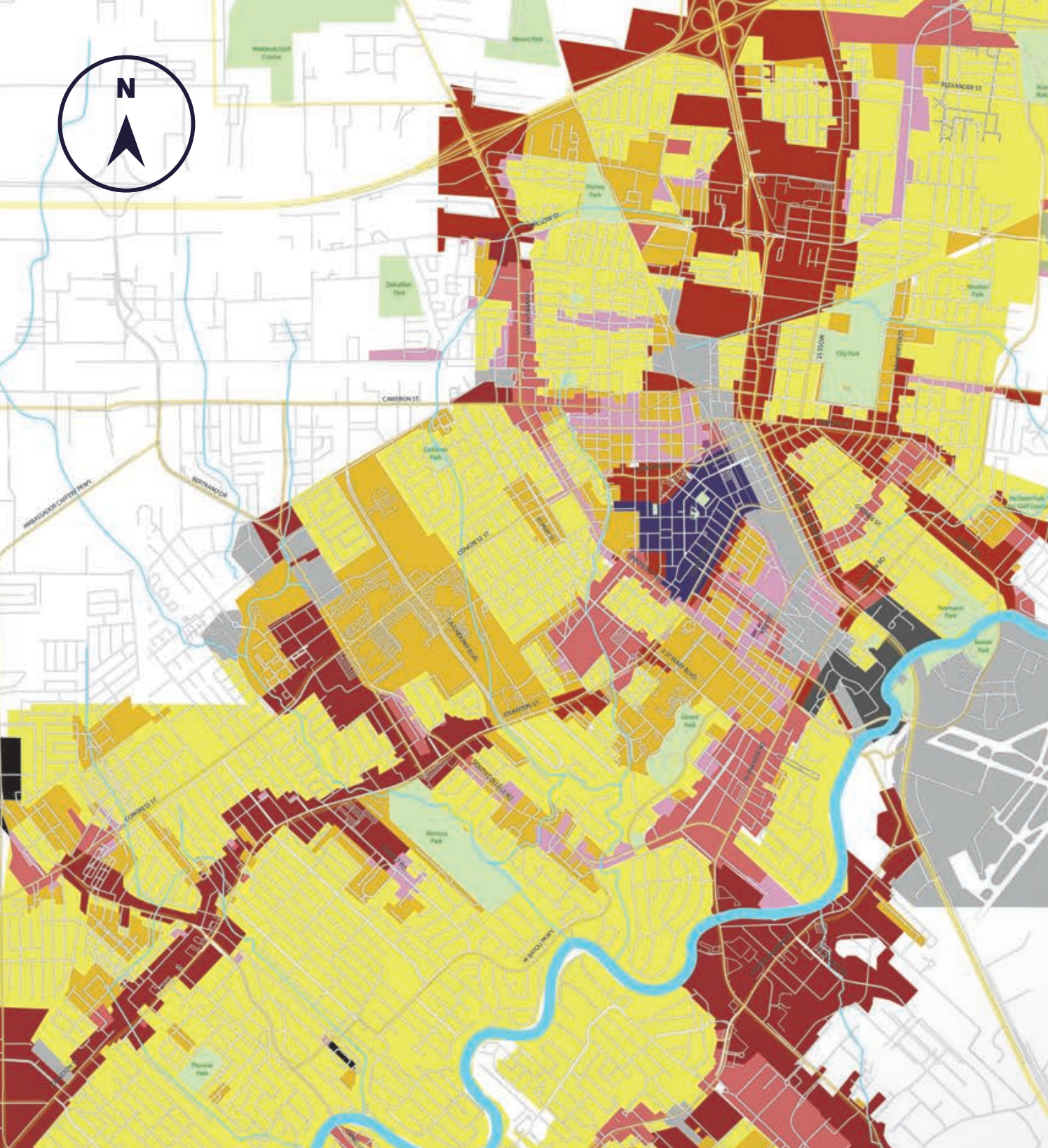

Zoning

RS-1	MN-1	D	A
RM-1	CM-1	MN-2	PD
CH	IL	IH	

Source: Lafayette Consolidated Government



LANES	PEAK HOUR	HIGH (.07)	LOW (.01)
(1)	800	11,428	8,000
(2)	1,600	22,857	16,000
(3)	2,400	34,285	24,000
(4)	3,200	45,714	32,000
(5)	4,000	57,142	40,000
(6)	4,800	68,571	48,000

(Institute of Transportation Engineers, 2009)

Traffic Counts

- 4 Lane Roads
- Must remain 4 lanes to maintain current capacity
- Close to 4 lanes
- Shared Roadway
- Separated Bike Lane
- Bike Lane
- Multi-use Path

Source: Louisiana Department of Transportation and Development (2021)



3

Public Participation

It is crucial to engage resident experts as well as the local community to ensure the success of projects like Bicycle Lafayette. In-person meetings were held at the Rosa Parks Transportation Center in Downtown Lafayette to gather important community input regarding new bike routes for the City of Lafayette.

3.1 Experts Charrette

3.2 Community Meeting

3.3 Public Questionnaires

3.1 Experts Charrette

The design team engaged the Lafayette Pedestrian and Bicycle Committee (LPBC) in a charrette session to gather targeted input regarding regularly used routes, safety, and potentially desirable connections. After a brief presentation introducing the project team and project goals, attendees were divided into smaller groups. These groups worked together to evaluate the project goals and discuss the potential benefits of the precedents presented. As part of the discussion, the groups covered topics of safety, connectivity, and major barriers to implementation, among others. Using maps and diagrams, they were able to identify important issues and propose various recommendations.

The LPBC's input was invaluable to the design team. Their unique knowledge provided a keen insight into the challenges the city currently faces with its bicycle infrastructure. The resulting suggestions and information gathered during this charrette session helped inform the Bike Lafayette Master Plan.





3.2 Community Meeting

The local community was invited to attend a public meeting to learn more about the goals and focus of the Bicycle Lafayette project and provide input to the design team. Over 50 community members attended the meeting to ask questions, share ideas, and participate in the planned activities.





During the meeting, attendees were asked to prioritize the goals presented by the design team. Using small stickers, participants selected the goals they felt were most important to them. This exercise provided a quick take on the communities' priorities and allowed all participants to see the results quickly. We found that safety, connections, equity, and comfort were the top priorities for this community.

For the second activity, participants were asked to "build" their ideal roadway sections to incorporate bicycle lanes

in combination with other streetscape elements. Participants were divided into groups of eight people or less and provided with various scaled parts and pieces of streetscape components. The groups were tasked with working together to create their idyllic street sections based on the prioritized goals. Design team members were available at each group table to answer questions and provide guidance. The exercise provided the design team with potential ideas to incorporate into the master plan and helped the participants realize the potential of what is possible.

3.3 Public Questionnaires

To supplement the expert’s charrette and public meeting, the team distributed a survey to the general public in an effort to capture additional information and gather feedback from those unable to attend the meetings. The questionnaire had a healthy response rate collecting a total of 238 responses from the community.

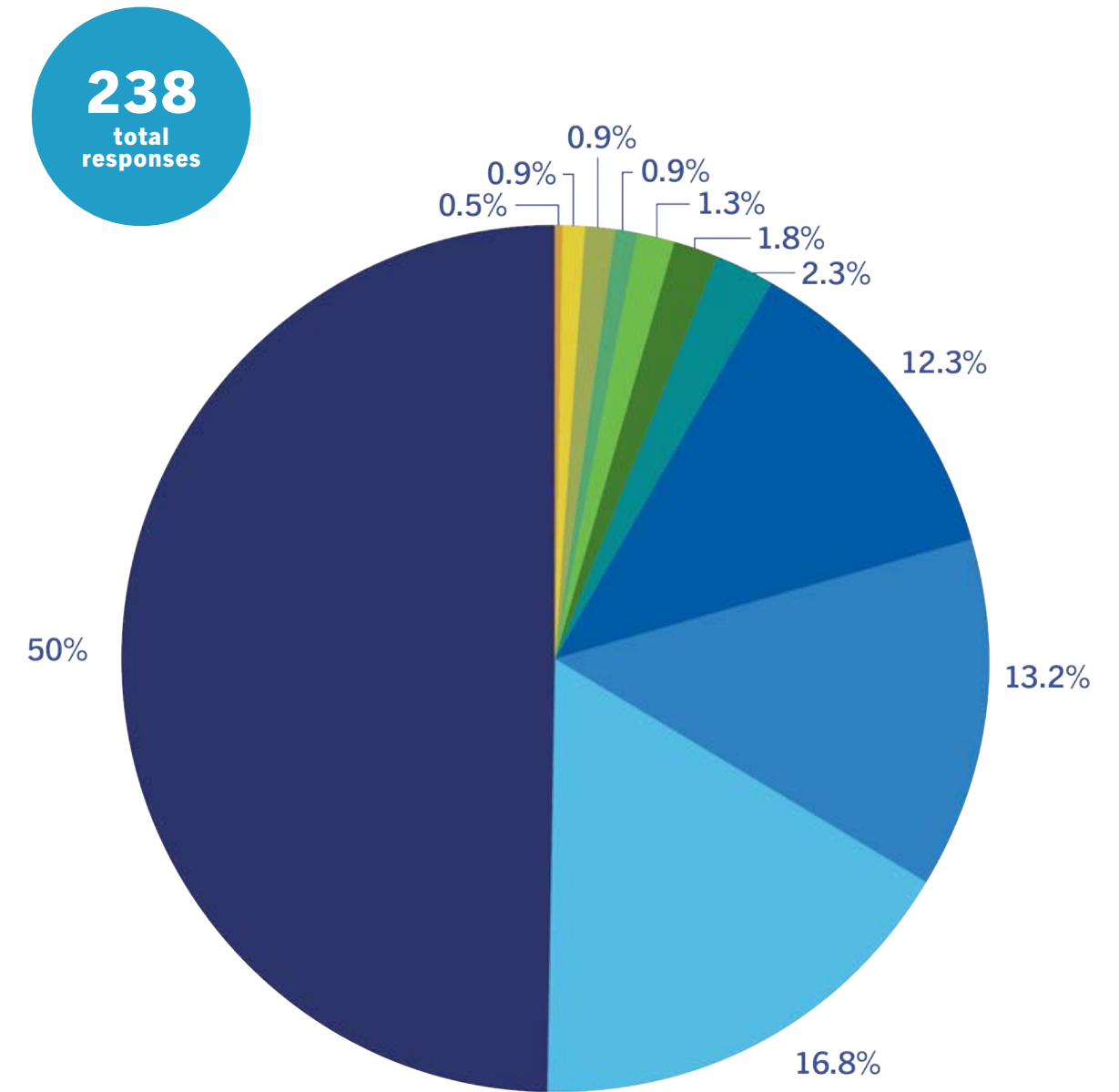
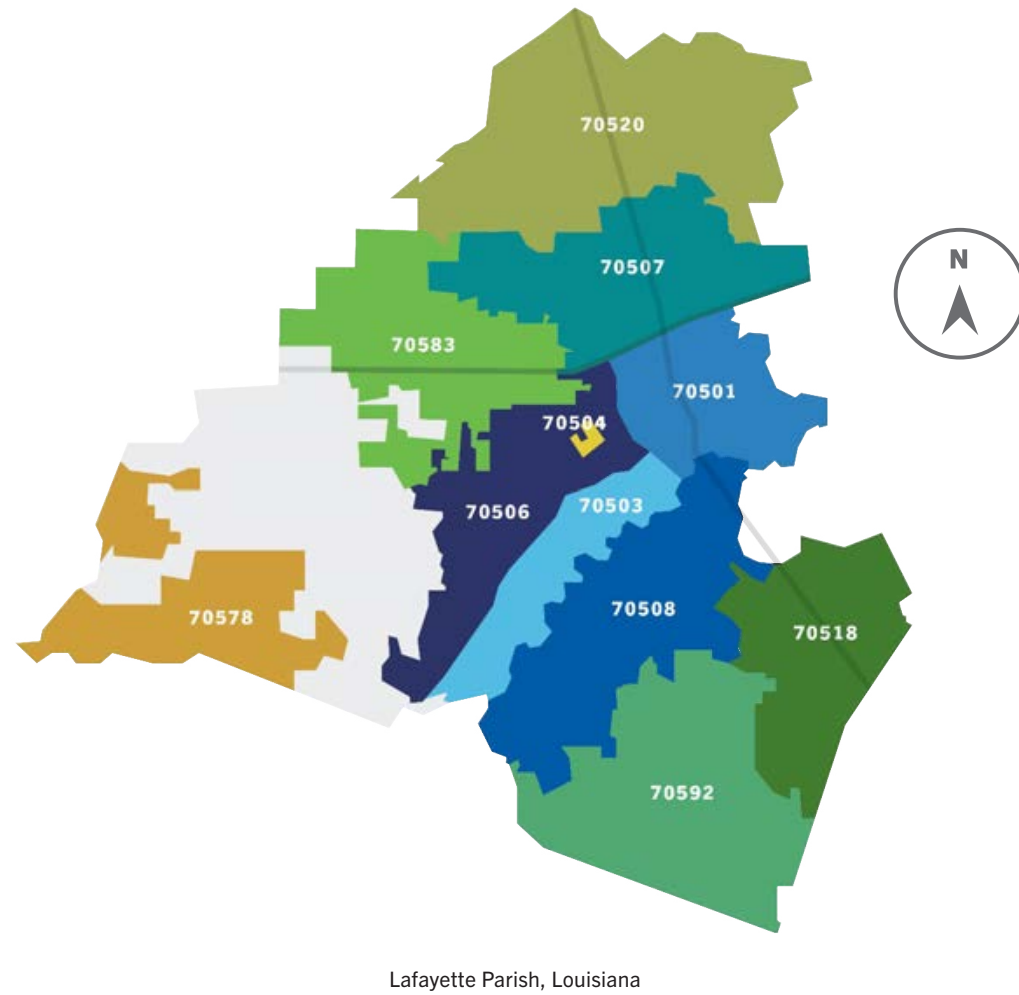

Figure 3A_ Questionnaire Responses by Zip Code
Questionnaire conducted using Google Surveys



Least Protected

Most Protected

3.3.3 Road Rankings

As part of the survey, various roadway sections were presented, illustrating multiple scenarios for the organization of streetscape components. The focus of this effort was to gather input from community members regarding their comfort levels and preferences for each scenario. The various options showed different levels of separation and protection of bicyclists using raised bike lanes, curbs, planting strips, and trees for buffering and shade.

Survey participants evaluated the various roadway sections presented and ranked them according to their preferences. The results consistently show that community members prefer roadway sections with separated bike lanes. The more popular options also provided more protection using curbs and planted areas. The inclusion of trees to provide shade and buffer travel lanes from bike lanes was the most popular. In contrast, the options with shared bike lanes and separated but unprotected bike lanes predominately received lower rankings. This information helped determine the approach to developing design recommendations for various roadway sections.

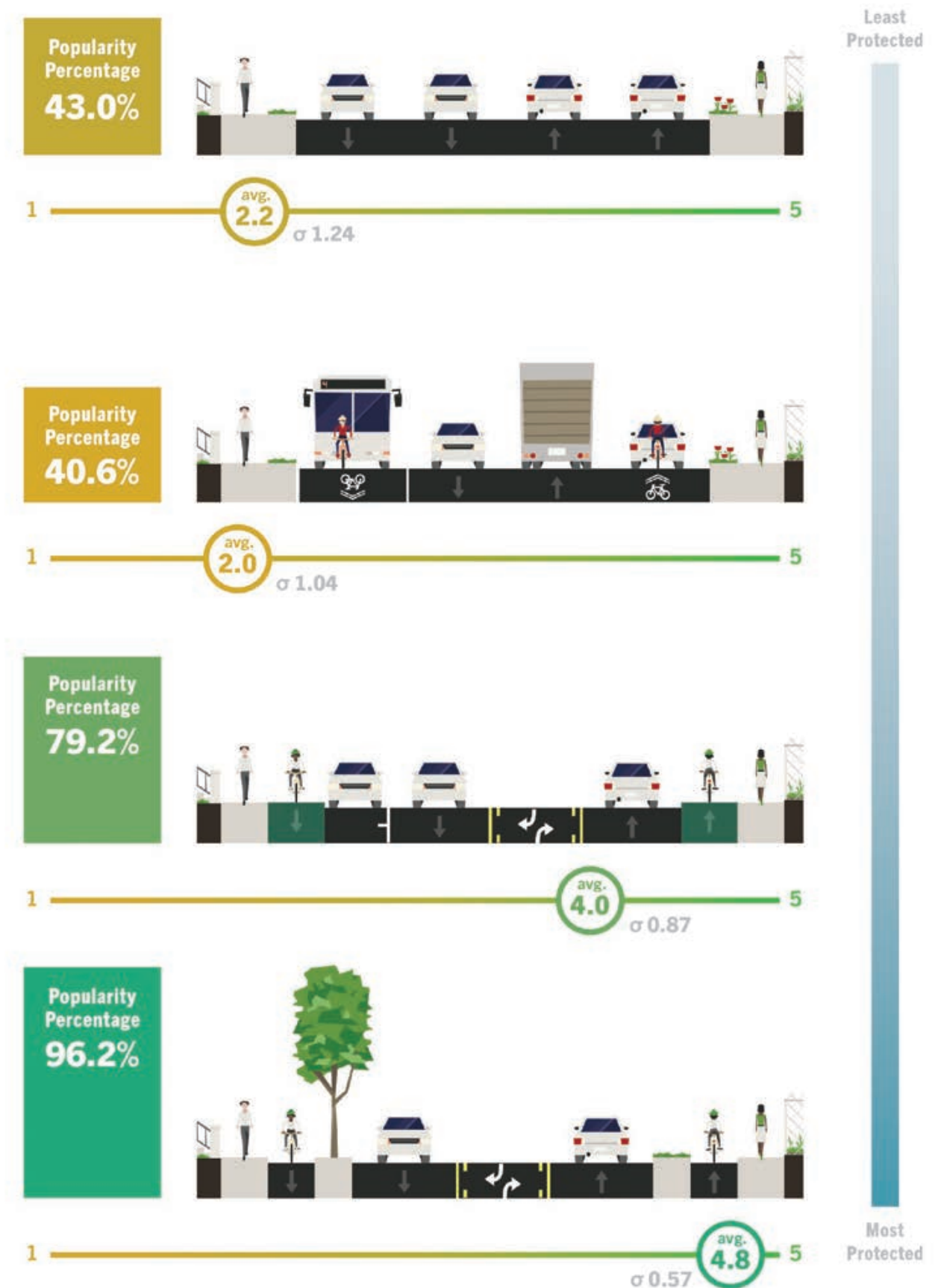

(Right)Figure 3C_Small Street Section Preference
Street section images created with Streetmix.net

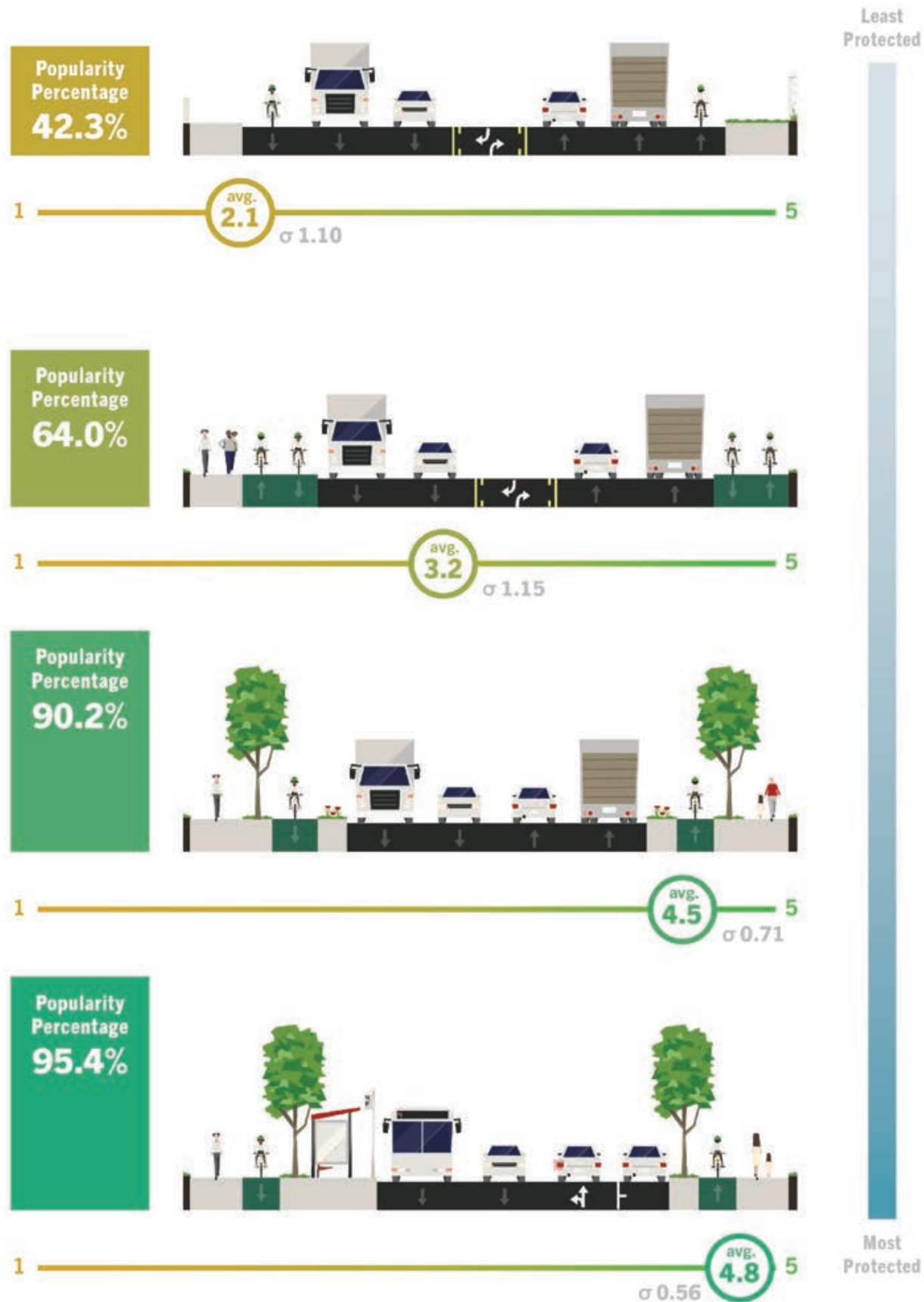

Figure 3D_ Medium Street Section Preference
Street section images created with Streetmix.net

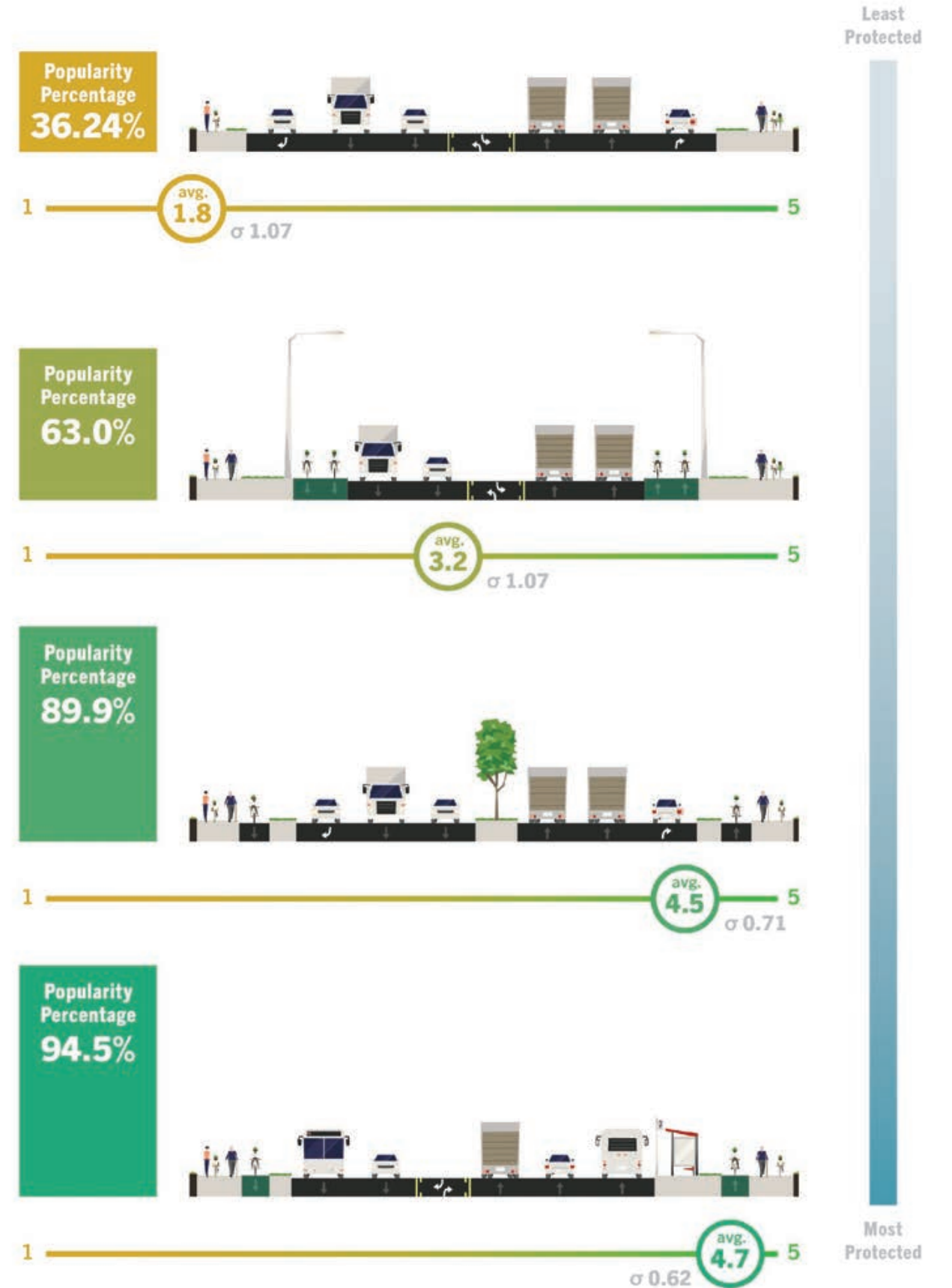

Figure 3E_ Large Street Section Preference
Street section images created with Streetmix.net

3.3.4 Public Responses

In addition to the responses to the survey questions, participants provided more detailed thoughts on the condition of the bicycle infrastructure throughout the city. These responses are eye-opening and highlight the seriousness of the deficiencies of the current bicycle routes.

***I refuse to use—
Johnston Street’s
‘bike lane.’***

***Myself/my kids could easily ride bikes to
work/school if safe cycling infrastructure
existed, which would also take a car or
two off the road!***

***We would love to bike more around the
city, but it is too dangerous—especially
with children.***

***Crossing major
roads here is
suicidal!***

***The lack of bicycle
infrastructure here in
Lafayette is among the
most dangerous/scary
that I’ve seen.***

***A separate
walking/biking trail
would be amazing to
get around the city.***

***I would use my
bike more for
local errands if
I felt safer.”***

***Lafayette roads are unsafe as they stand
now—The future growth of Lafayette
depends on young people wanting to reside
in a community that values safe travel
lanes for cyclist.***

***After being hit while using a bike lane in
Lafayette, I avoid the provided bike lanes.***



4

Bicycle Network

To best organize the Bicycle Lafayette network, routes are color coded and connect specific areas based on data analysis seen in Chapter 2. The system is also organized around a loop and spoke design, often seen in other modes of transportation and easy for users to understand. The proposed first phase of the network is the Véloop, an 8.8 mile loop that blurs the lines between a commuter route and recreational route and connects seventeen distinct Lafayette neighborhoods.

- 4.1 Connection
- 4.2 Network Map
- 4.3 Véloop

4. BICYCLE NETWORK

4.1 Connection

The network created from the data considerations are based on maps used for almost a century in public transit. This color coded route system, along with public assets, has origins traced to Harry Beck and Massimo Vignelli. This color coded network creates a natural wayfinding system which orients users and encourages use of the bike routes (Kent, Alexander).

The main route that organizes the system is an 8.8 mile loop. This loop, named the Véloop (a combination of the French word vélo meaning bike and the English word loop), connects seventeen distinct Lafayette neighborhoods, eleven city assets, four schools, and two higher educational institutions. The loop is bisected by a route that follows Coulee St. John from Girard Park to Downtown Lafayette at Congress Street. Proposed are two Landmark trailheads located at Pontiac Point (access to historic districts) and Rotary Point (access to the Vermilion River). Primary and secondary trailheads are then filled in at either destinations or crossings with other color coded bicycle routes. These trailheads are further explored in [Chapter 8](#).

Many modes of transportation organize circulation around a loop and spoke system. Some notable loop and spoke systems are

the trains in places like Tokyo, Berlin and Chicago. Most large North American cities have highway systems with this same organizing system as seen in cities such as Atlanta, Houston and Dallas. Portland, OR is actually planning a “green loop” for bicycling in its urban core (<https://www.portland.gov/bps/planning/green-loop>). This system of loops and spokes is already in the recognizable language of most people.

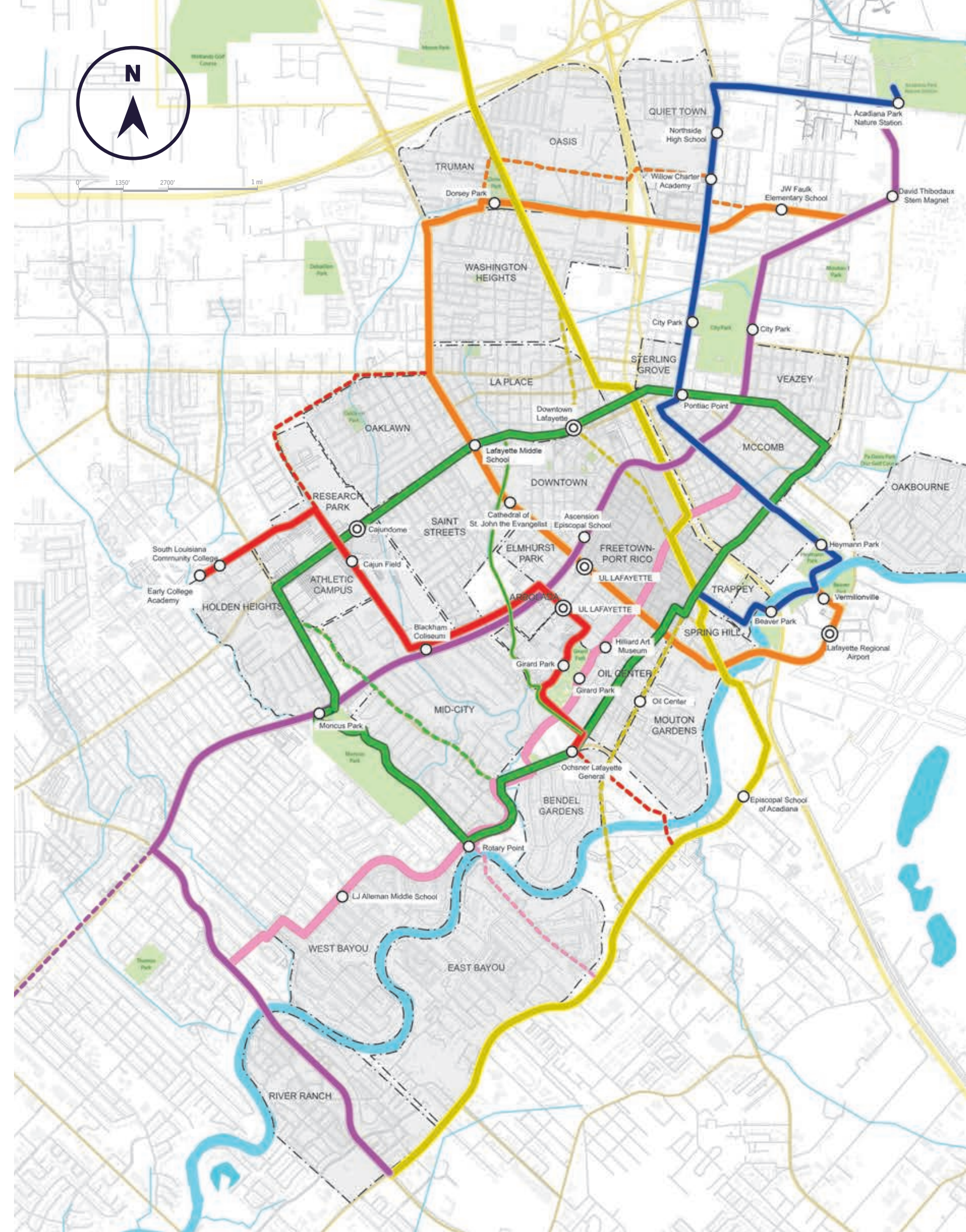
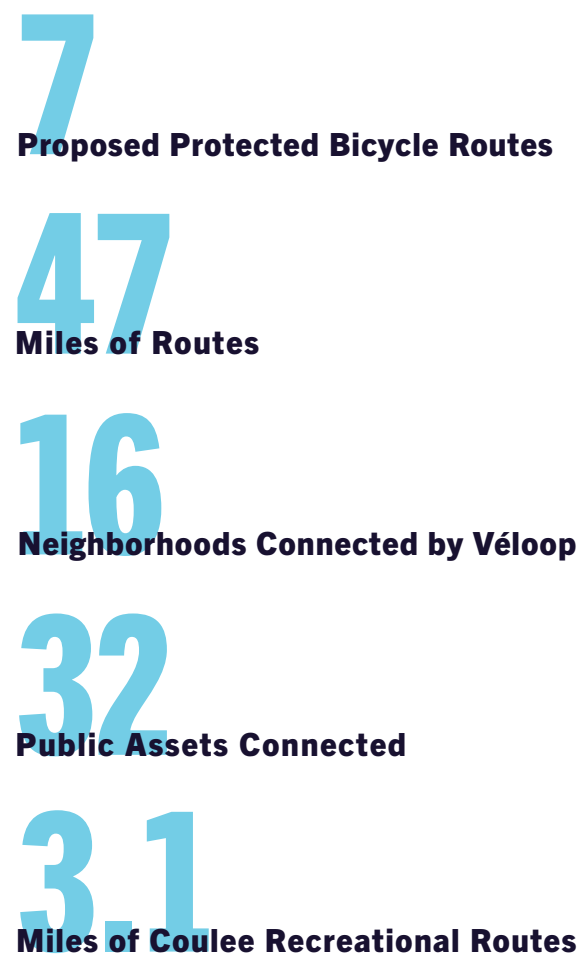

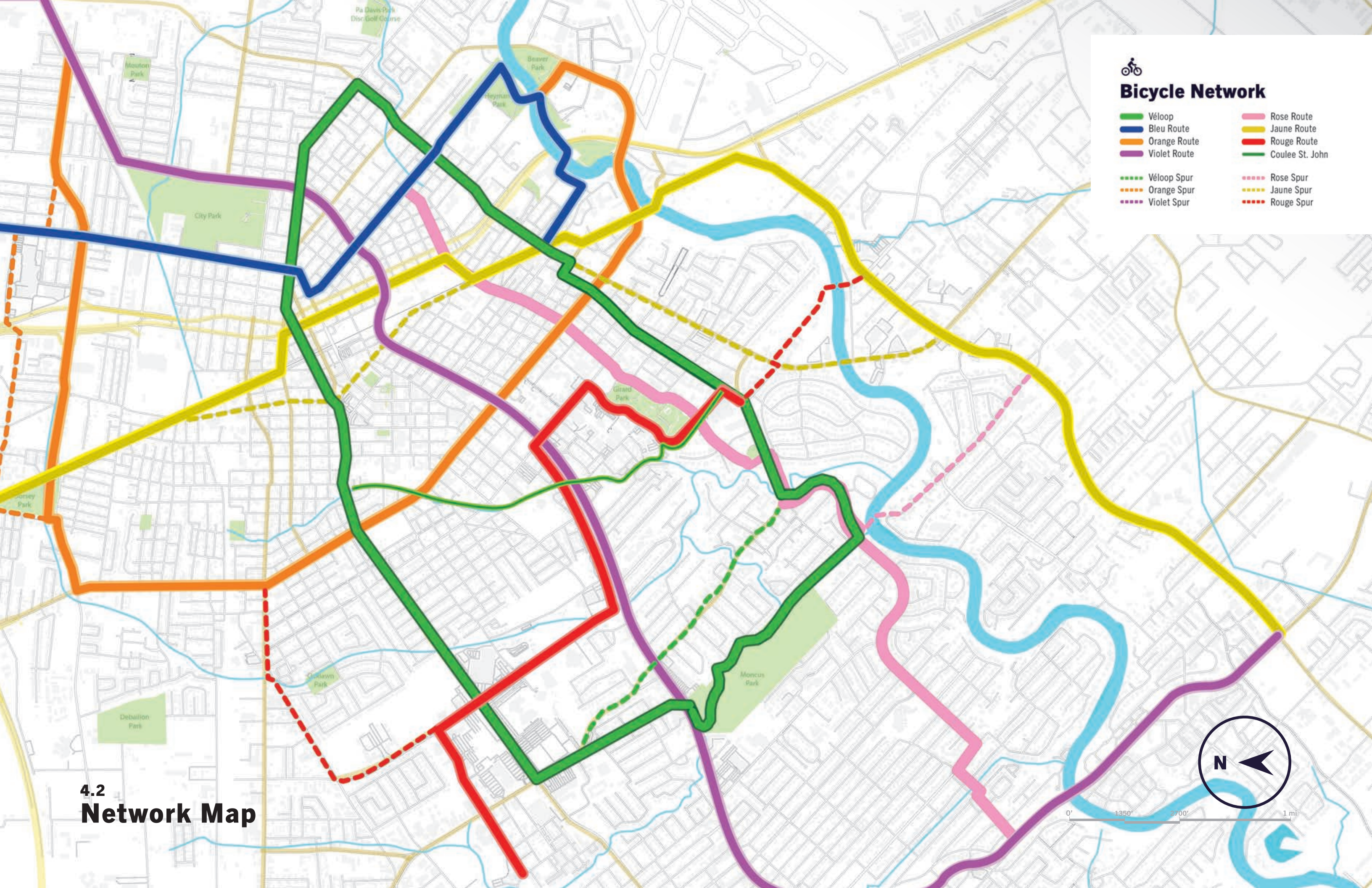

Bicycle Network

- | | |
|--------------|-----------------|
| Véloop | Rose Route |
| Bleu Route | Jaune Route |
| Orange Route | Rouge Route |
| Violet Route | Coulee St. John |
| Véloop Spur | Rose Spur |
| Orange Spur | Jaune Spur |
| Violet Spur | Rouge Spur |

4.2 Network Map



0' 1350' 2700' 1 mi

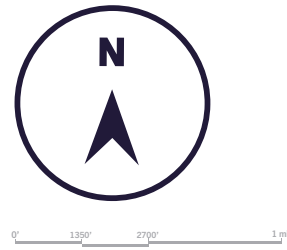

Urban Core



Downtown

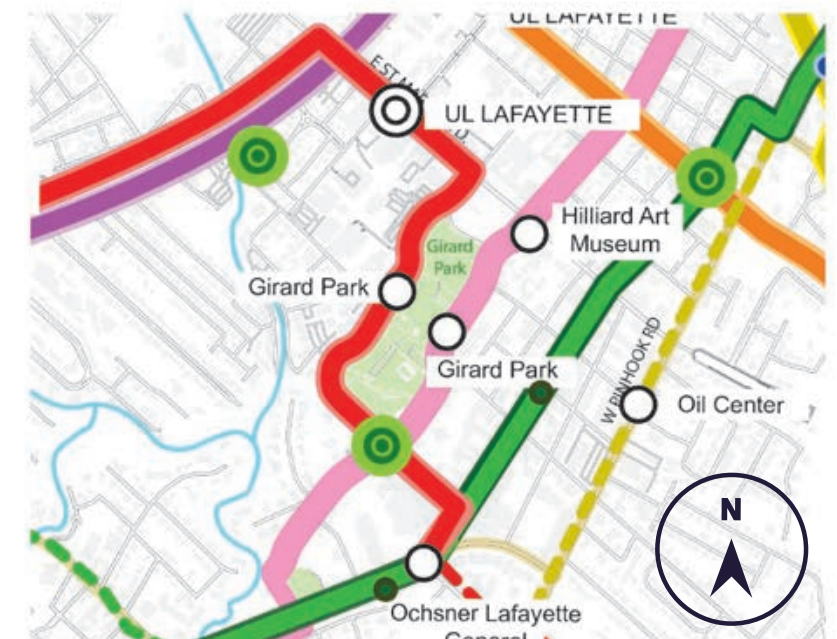

Oil Center and UL Lafayette Campus

4.3

Phase 1: Get in the Loop

In order to ensure that the first phasing of the Bicycle Lafayette network is complete enough to encourage its use by bicyclists, the main organizing element of the network is a loop. This loop is an 8.8 mile loop, named the Véloop, connects seventeen neighborhoods and eleven city assets. The route is designed to connect Lafayette's urban core. This loop is then bisected by a route along Coulee St. John which connects the Oil Center to Downtown where the majority of the path is not along roadways.

This also allows the connection to the Vermilion River at Rotary Point and a connection to the Sterling Grove National Historic District at Pontiac Point. Landmark trailheads (see [Chapter 8](#)) are best located at these two ends, better connecting the city to the river.

Major city assets that are connected by this phase 1 approach include the Cajundome, Cajun Field, Moncus Park, City Park, Ochsner Lafayette General Medical Center, University Hospital & Clinics, Rotary Point, Pontiac Point, the Main Library Branch, Downtown and the Oil Center. Schools that are connected

to neighborhoods include Lafayette Middle, Lerosen Preparatory, Paul Breaux Middle, and Dr. Raphael A. Baranco Elementary.

This protected bicycle route also connects neighborhoods of varying levels of socioeconomic families. This can best be seen in the [Chapter 5](#) route diagrams (see the Véloop linear diagram). Around half of the Véloop has more than 20% of households without cars and approximately two-thirds of the route have over 50% of households living in poverty. This connects those without access to better jobs and the ability to better connect to the overall community. The Véloop is a community connector.

After the Véloop is completed, the other six routes should be strategically implemented in segments that always link back to the Véloop. After the completion of the seven routes, spur routes should be prioritized. This does not mean that there may be local or regional routes that can tie into the system.

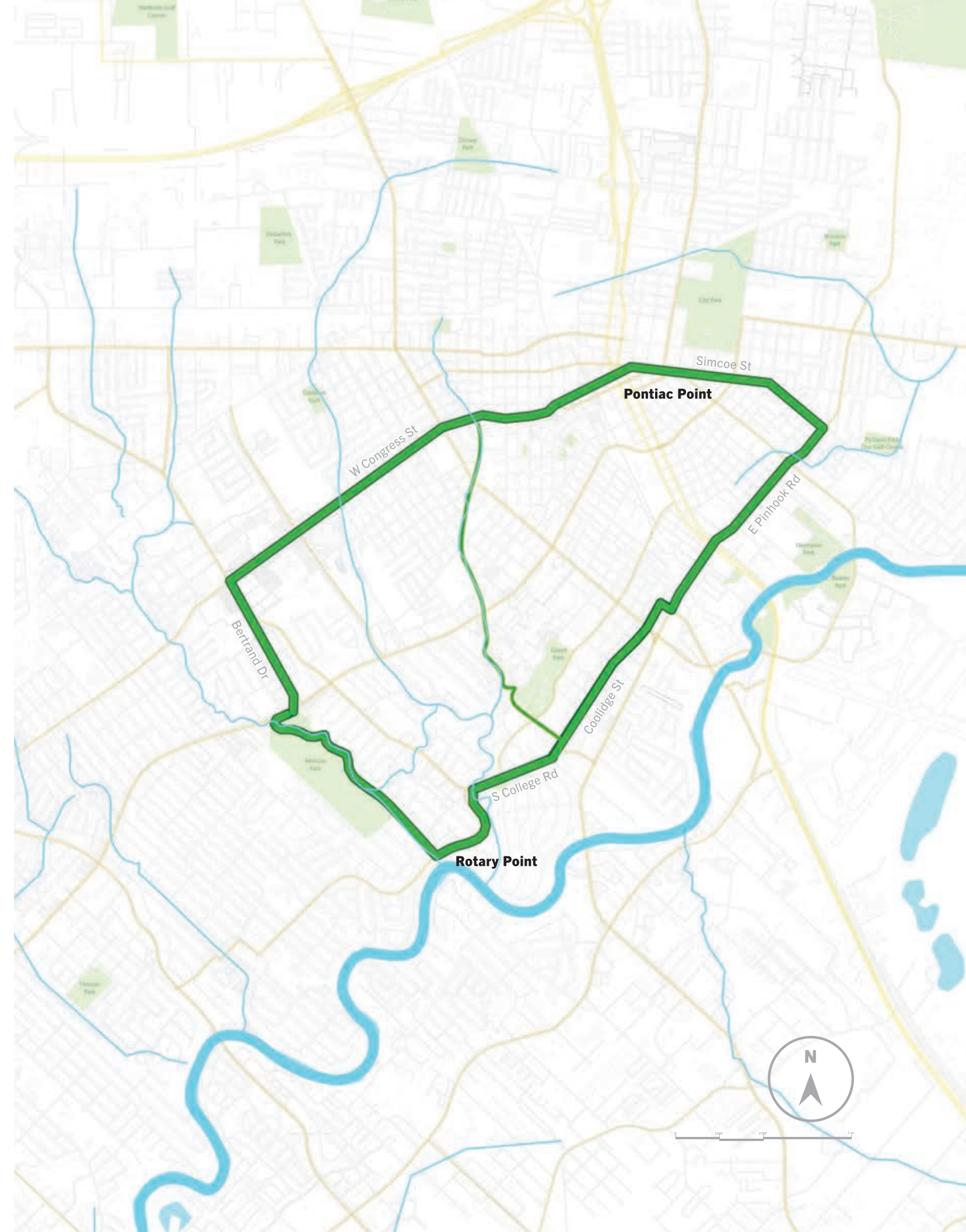

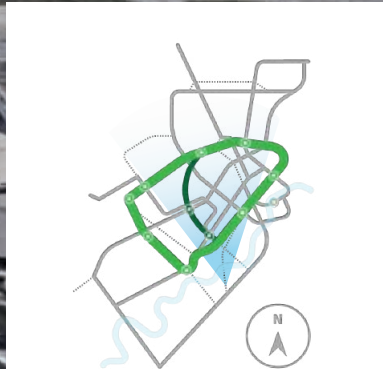

Vélopop at Oil Center
Image sourced from Google Earth Pro

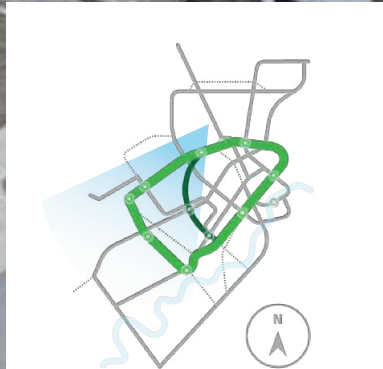

Véloop at Downtown
Image sourced from Google Earth Pro

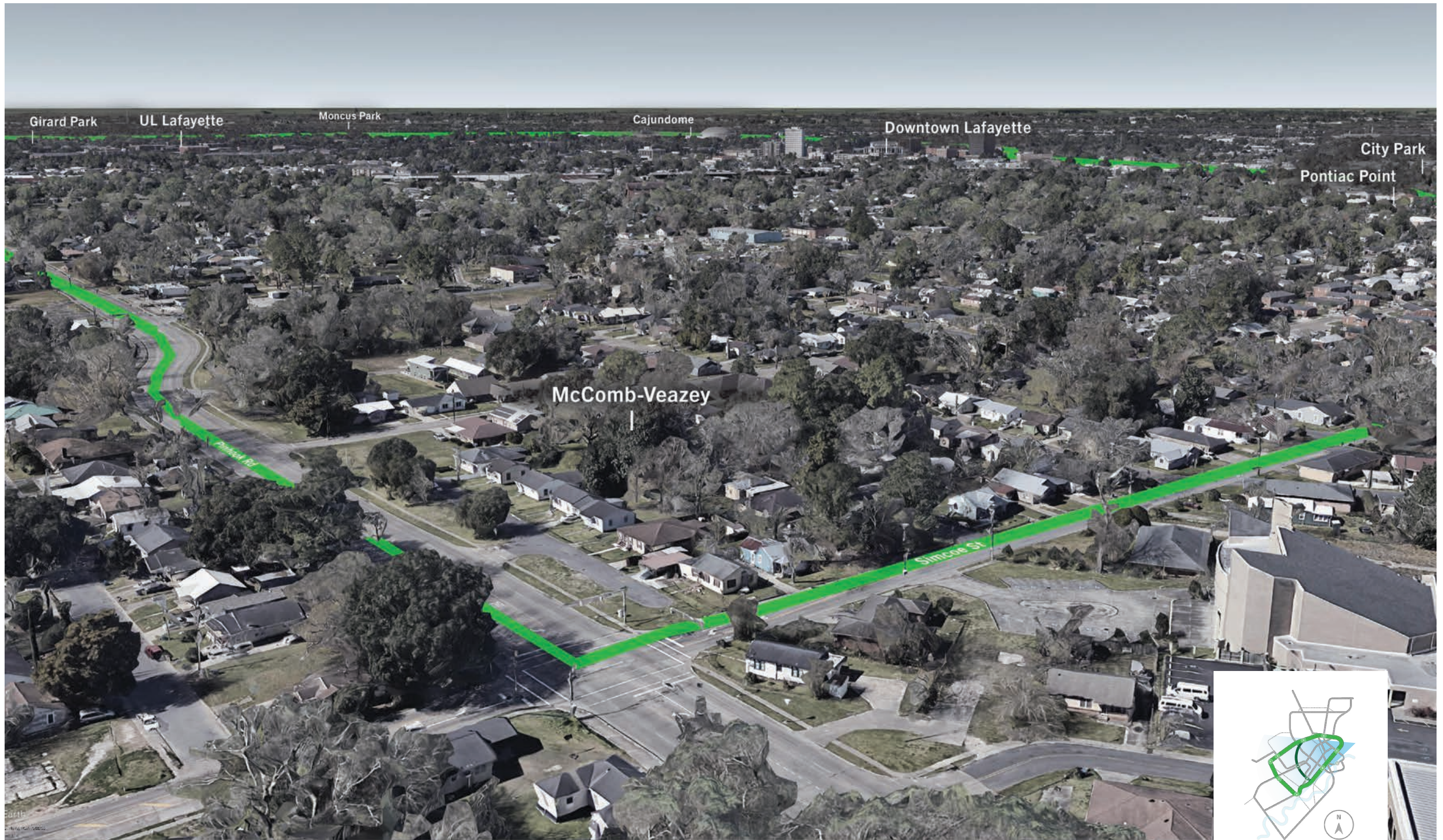

Véloop at McComb-Veazey

Image sourced from Google Earth Pro

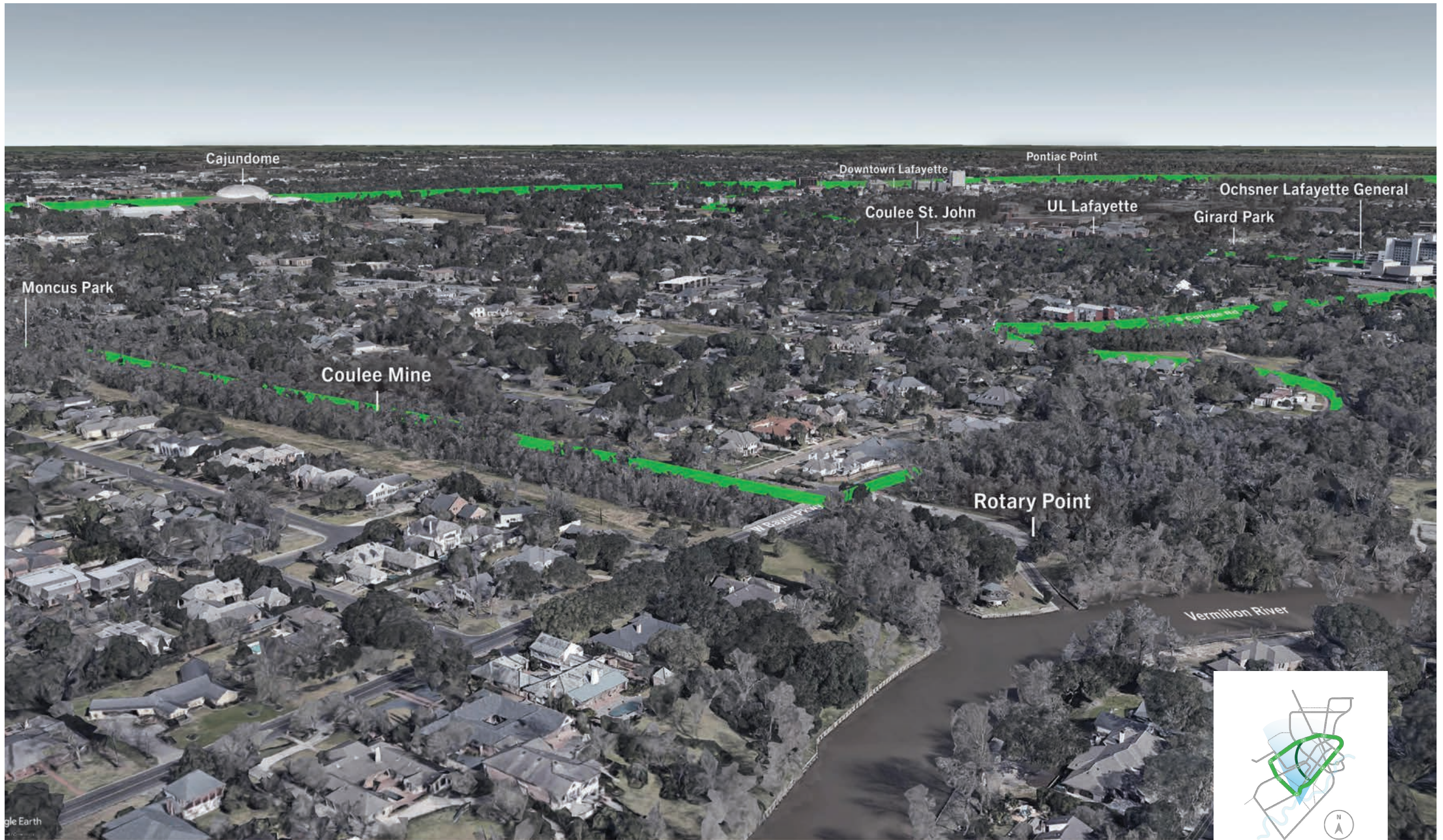

Véloop at Rotary Point

Image sourced from Google Earth Pro

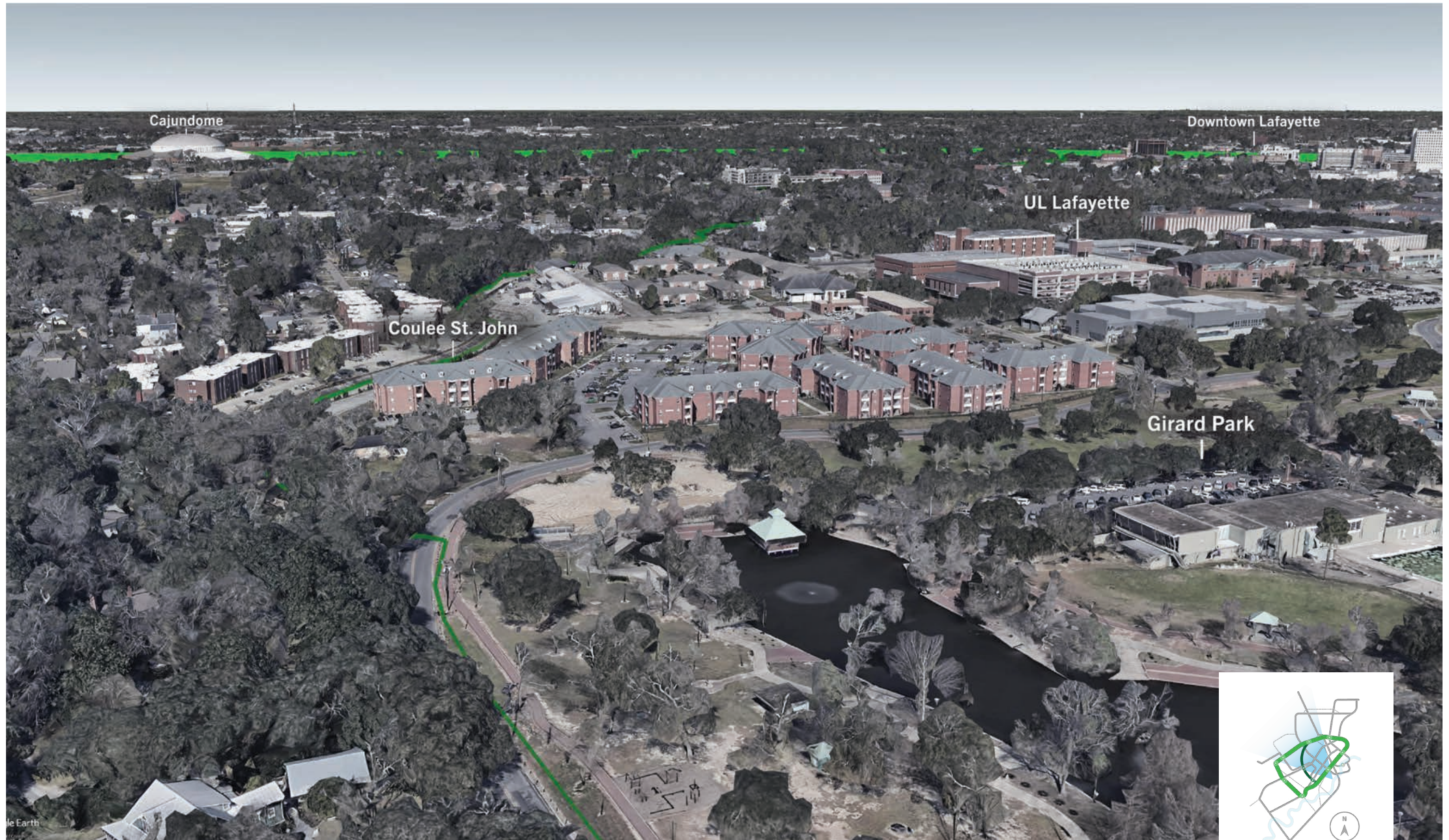

Cajundome

Downtown Lafayette

UL Lafayette

Coulee St. John

Girard Park

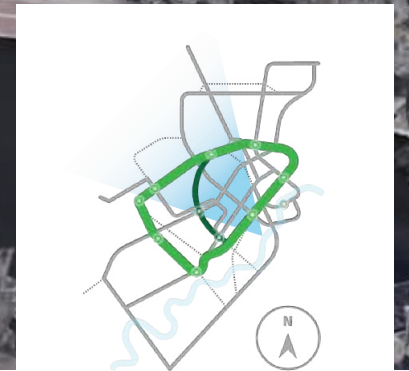

Véloop at Girard Park

Image sourced from Google Earth Pro

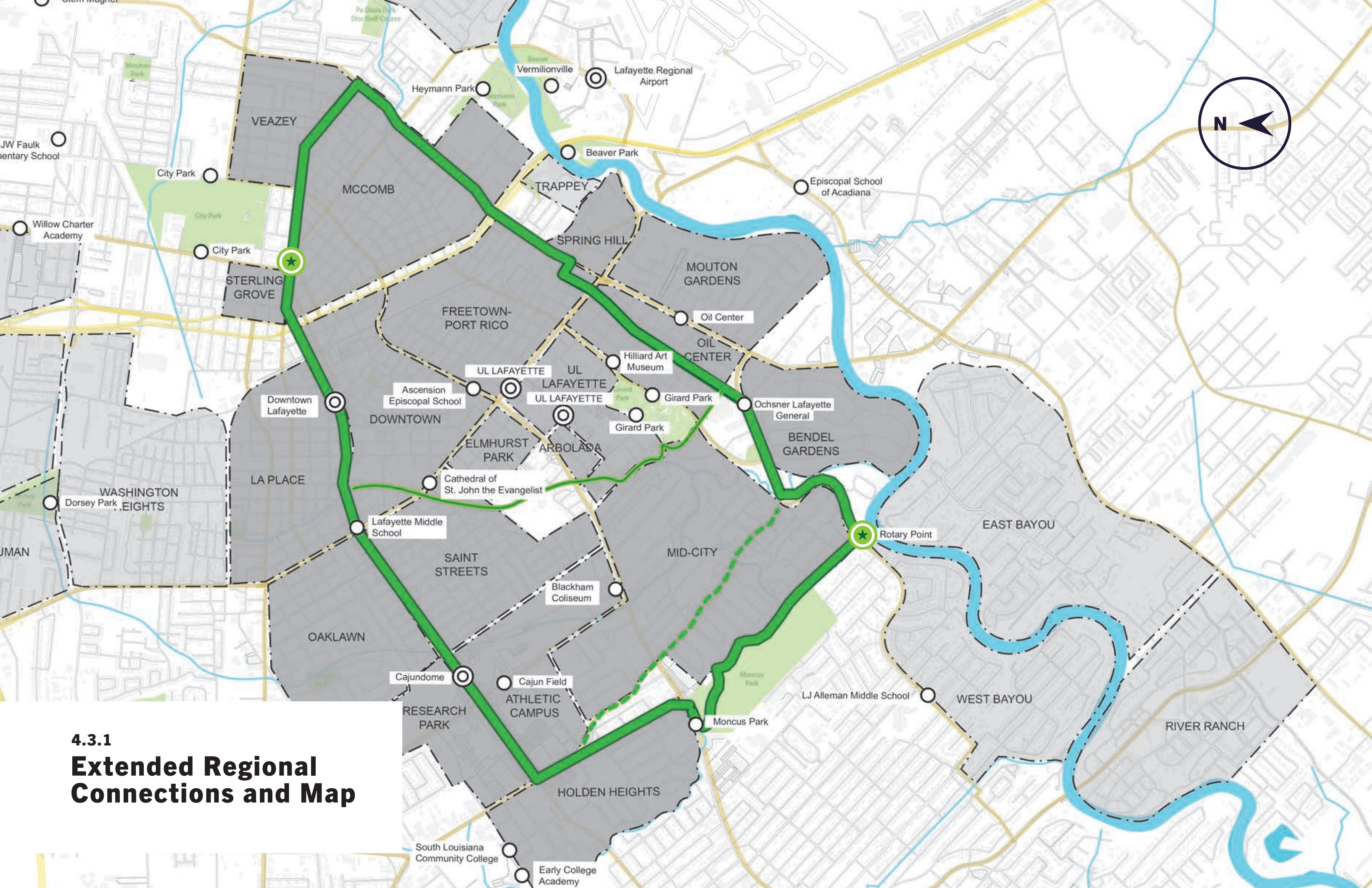

4.3.1
Extended Regional
Connections and Map



4.3.2 **Véloop Vision**

Véloop along East Pinhook

The vision for the Véloop is to provide safe and comfortable bicycle routes that offer more equitable connectivity throughout the city. Bicycle lanes separate riders from the roadway with continuous planters. The addition of trees provides shade and buffers bicyclists from vehicular traffic.



Véloop along West Bayou Parkway

This double-track bicycle lane elevates the riders and buffers them from the road with trees and generous planting areas. The layout takes advantage of the adjacent wooded edge to help provide shade and create a more pleasant riding experience. Native plants such as iris, juncus, palmetto, and wildflowers create a cohesive setting.



Véloop along Congress Street

The right-of-way width along this street allows for a central planting area that doubles as stormwater management, detaining water diverted from the road and using plantings to cleanse it before slowly releasing it into the drainage system.



Véloop through Oil Center

The Oil Center is a unique area of town requiring a slightly different approach. The existing street section is not conducive to adding separated bike lanes along the outside edges. However, the median provides ample room for a double-track bicycle path down the center while still allowing room for a robust planting treatment.



Véloop along Coulee Mine

The concrete coulee running between Rotary Point and Moncus Park presents an opportunity to create a unique riding experience. This stretch of the Véloop is less urban and more recreational. One side of the coulee is naturalized to provide a softer feel and allow new shade trees. Native plant material along the naturalized edge aids in stormwater detention and cleansing by slowing the water down and filtering out pollutants.



Véloop near Cajundome

The profile of this boulevard allows for the addition of large groups of trees and generous planted areas creating a true boulevard character. This profile also provides room for larger, more comfortable transit stops with more enticing amenities to encourage bus usage. As the city grows, this new roadway profile allows for future transit needs.





5

Route Diagrams

Two different types of diagrams were created by the design team in order to further test the network design and to begin to test typical sections using traffic data and available right-of-ways. The first set of diagrams are linear diagrams that consider connectivity of neighborhoods, city assets, as well as people of all socioeconomic groups (informed by data input from Chapter 2). These linear diagrams are set to scale and consider the visual identities as one travels between neighborhoods. The route sectional diagrams show in scale the available right-of-way widths and how multiple modes of transportation fit into the space available, always keeping in mind the comfortability and safety of pedestrians and bicyclists (informed by public input from Chapter 3) and maintaining the maximum capacities of current automobile traffic counts.

5.1 Route Linear Diagrams

5.2 Route Sectional Diagrams

5.1 Route Linear Diagrams

The color coded routes created by the Bicycle Lafayette plan allow for further data analysis in testing the routes themselves to see if they are accomplishing the project goals such as **equitability** (poverty rates and car ownership rates) and **connectivity** (neighborhoods and city assets). New zoning districts are suggested to ensure that the public investment in complete streets is met over time with private investments that aligns with the goal of creating a complete street.

How to Read Linear Diagrams

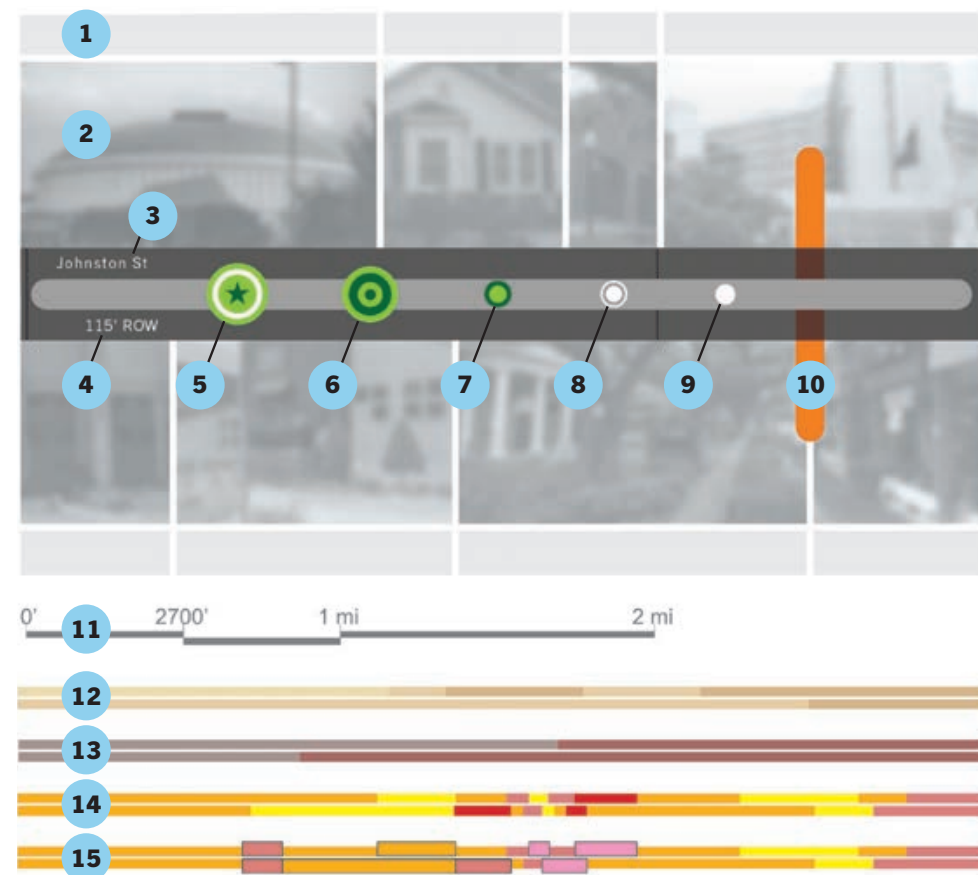

Legend

- 1** Neighborhood name
- 2** Visual of neighborhood along each side of route
- 3** Street name along route
- 4** Available width for public street(ROW)
- 5** Landmark Trailhead
- 6** Primary Trailhead
- 7** Secondary Trailhead
- 8** Regional Asset
- 9** City Destination
- 10** Intersecting Bike Route
- 11** Scale
- 12** % of people in poverty along each side of route
0% 100%
- 13** % of households without vehicle along each side of route
>1% 9% national figure >21%
- 14** Existing zoning along each side of route:
 - A** Agricultural
 - RS-1** Residential Single-Family
 - RM-1** Residential Mixed
 - MN-1** Mixed-Use Neighborhood
 - MN-2** Mixed-Use Neighborhood
 - D** Downtown
 - CM-1** Commercial-Mixed
 - CH** Commercial-Heavy
 - IL** Industrial-Light
 - IH** Industrial-Heavy
 - PD** Planned Development
- 15** Suggested changes to existing zoning

Véloop

8.8 mi



Poverty Rates



Households without Cars



Existing Zoning



Suggested Zoning

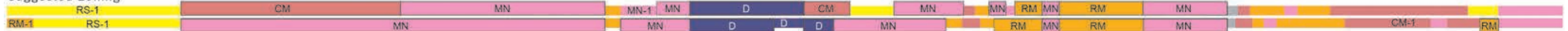

Orange Route

6.6 mi



Poverty Rates



Households without Cars



Existing Zoning



Suggested Zoning



Violet Route

8.9 mi

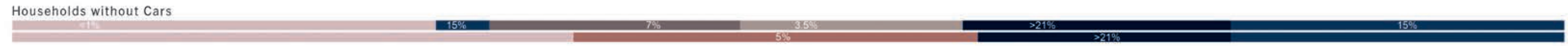
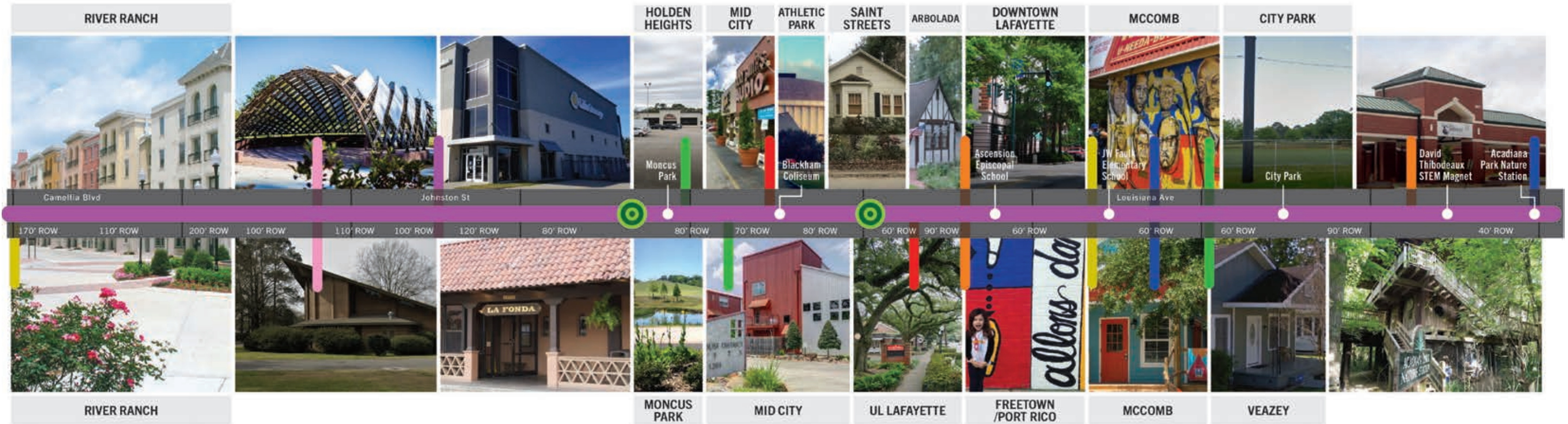

5. ROUTE DIAGRAMS

Rose Route

4.5 mi

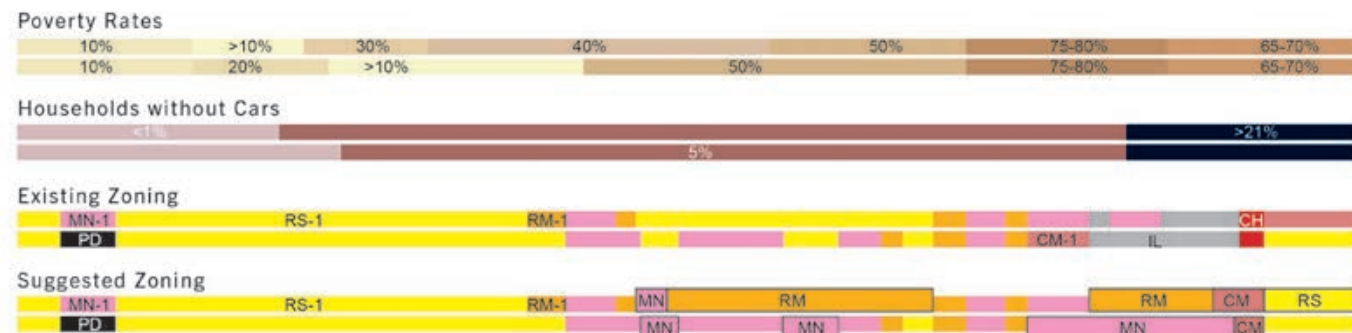

Rouge Route

4.1 mi



Bleu Route

6.1 mi

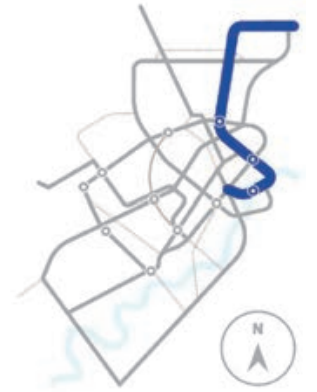

Poverty Rates



Households without Cars



Existing Zoning



Suggested Zoning

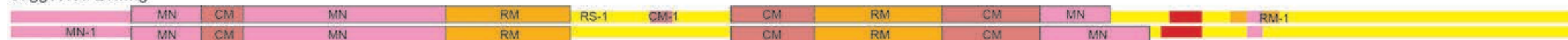

Jaune Route

8.1 mi

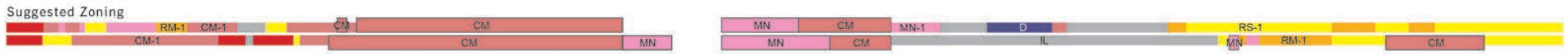
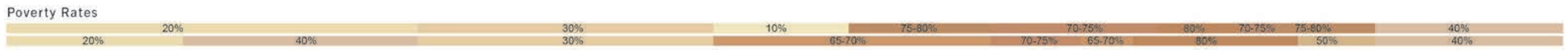

Coulee St. John, Recreational 2 mi

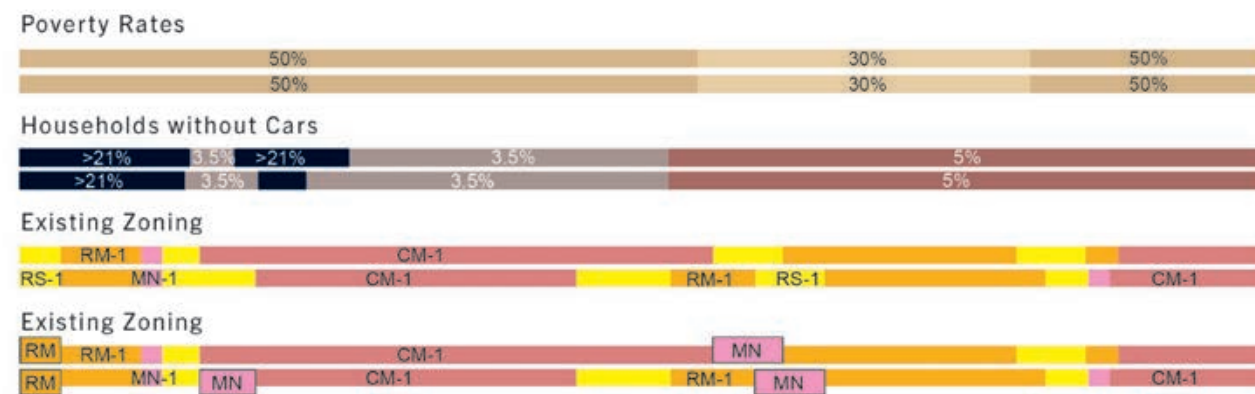
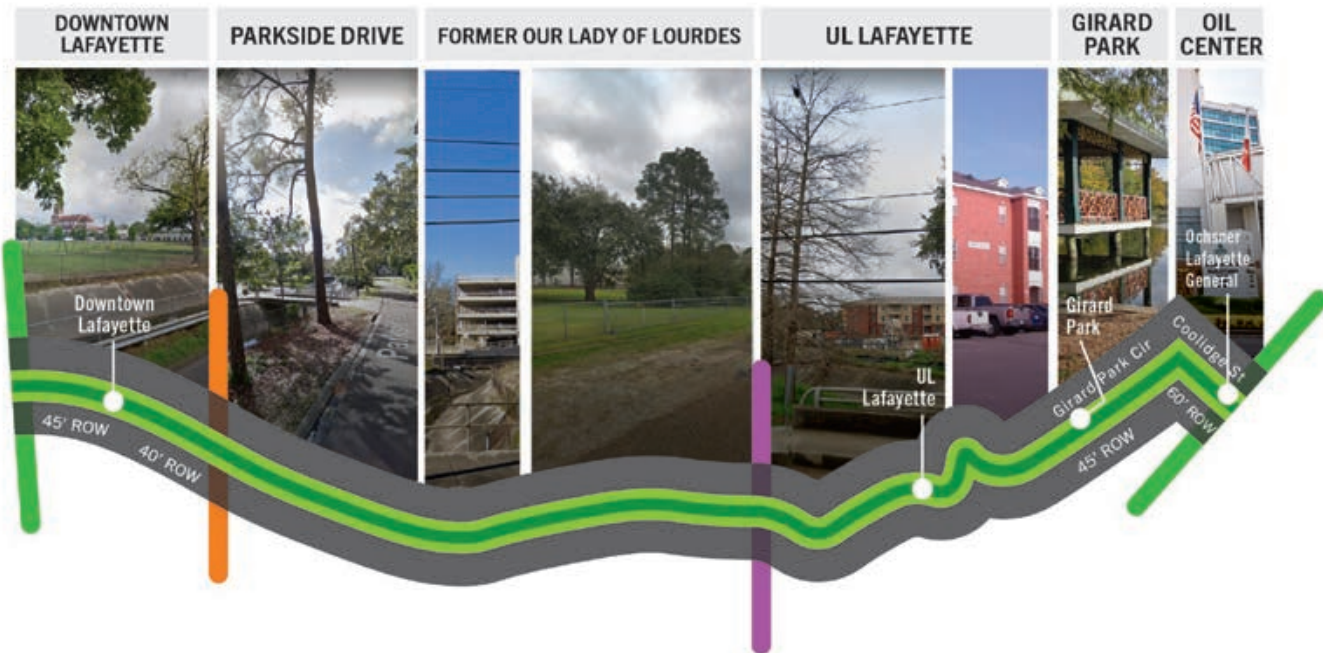

5.2 Route Sectional Diagrams

Each line is diagrammed for proposed typical street cross sections. These sections were then modeled in axonometric diagrams and typical intersection organizations were developed. The analysis on typical sections along the route take into consideration traffic counts to maintain automobile traffic capacities along the proposed routes (Institute of Transportation Engineers, 2009). In some cases, where not enough right-of-way(ROW) was available to maintain this capacity and provide for separated bicycle paths and landscaping, routes were adjusted. These street designs consider encouraging safer automobile traffic speeds, better practices rainwater management strategies, increased shading as to decrease average temperatures. Details to these designs were then developed such as curb profiles, curb cuts, bioswales, overflow drains, and proposed typical infrastructure locations. Street designs are explored in [Chapter 6](#) of the Bicycle Lafayette Master Plan Document.

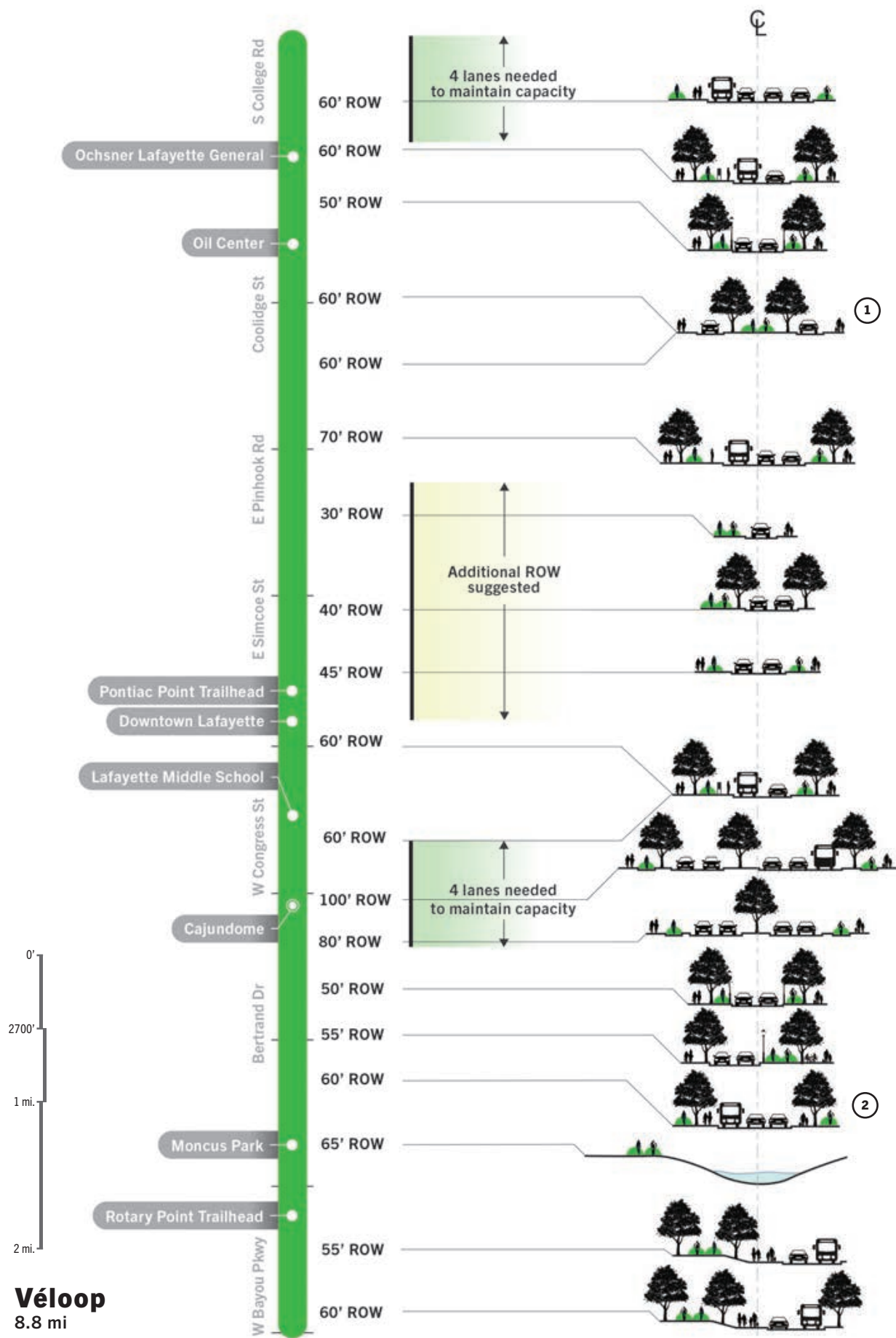

1

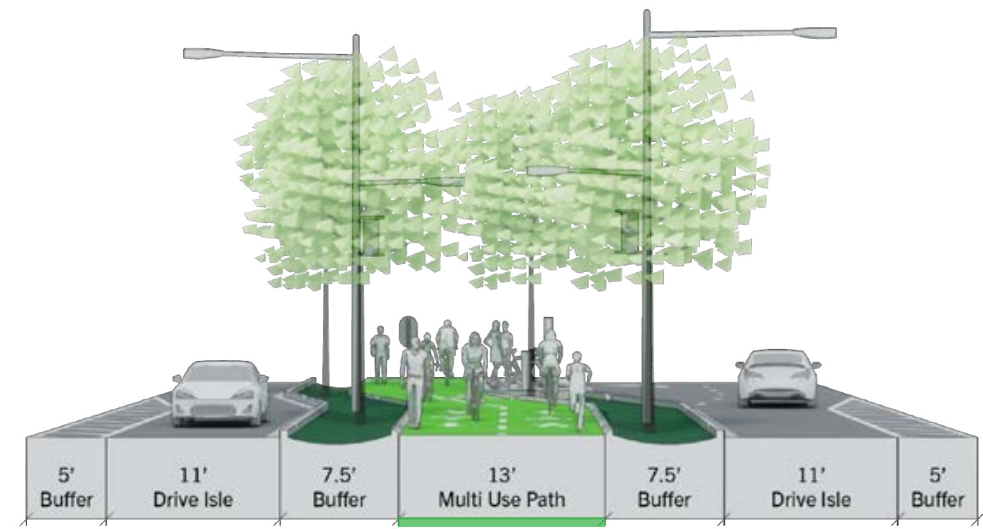

60' ROW

2

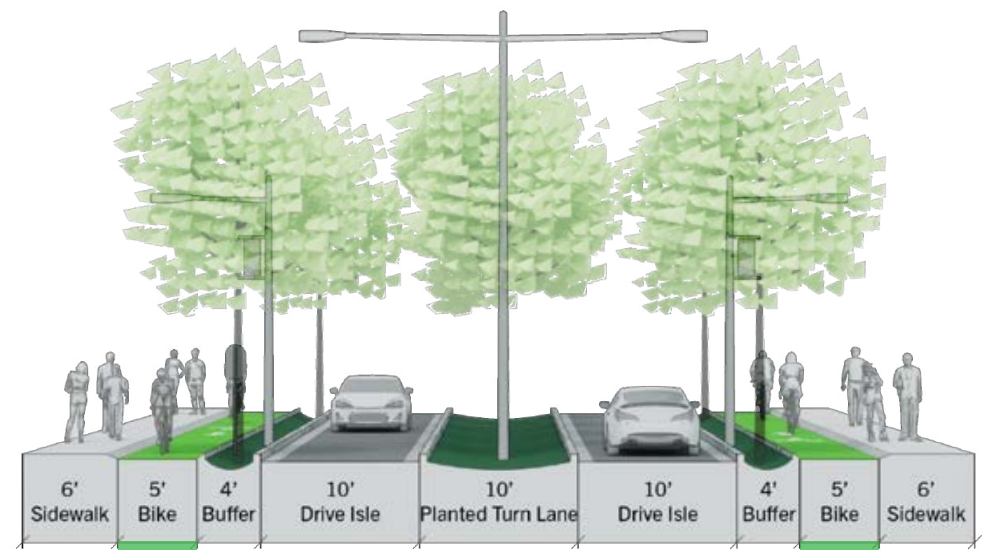

60' ROW

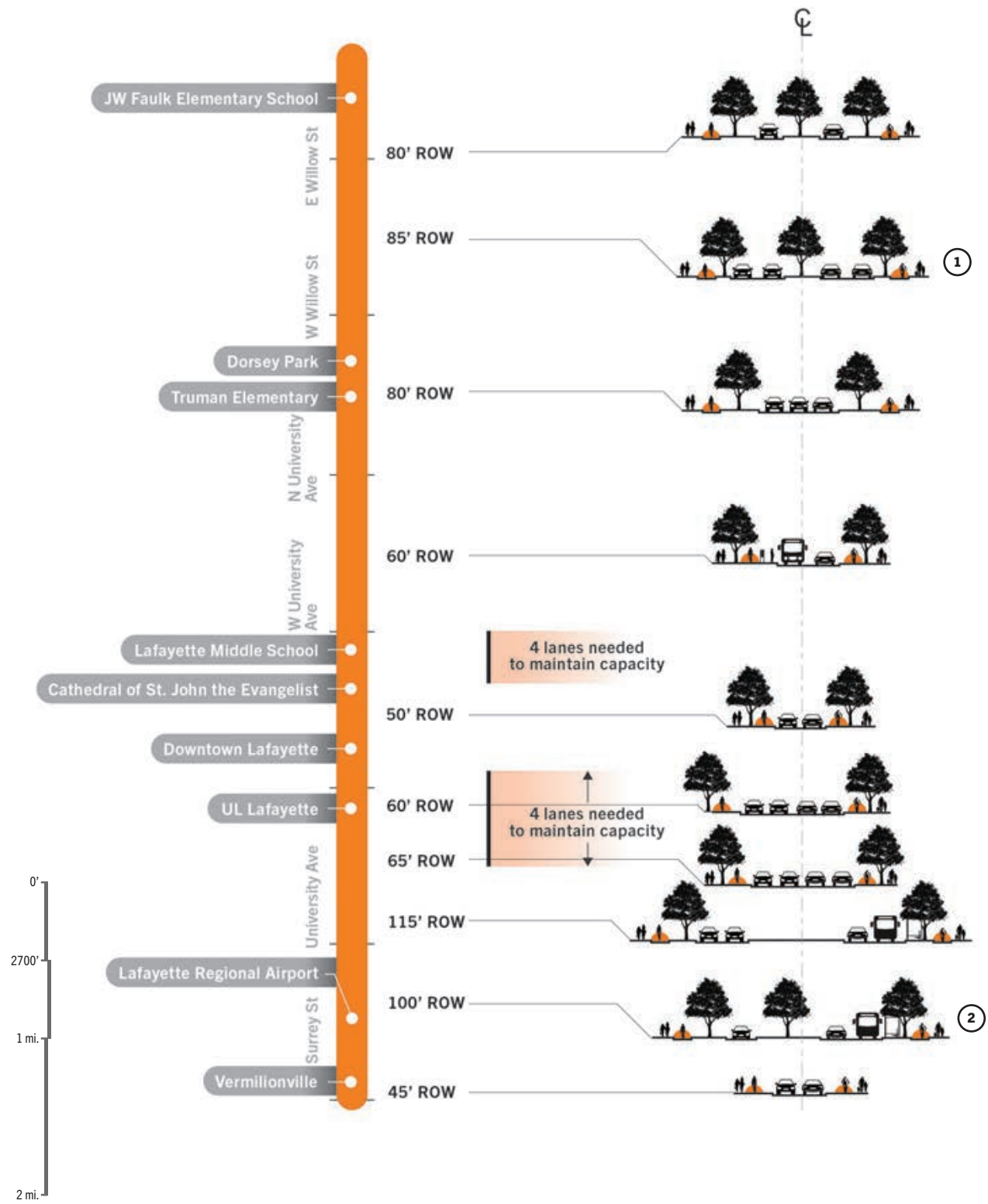

Orange Route
6.6 mi

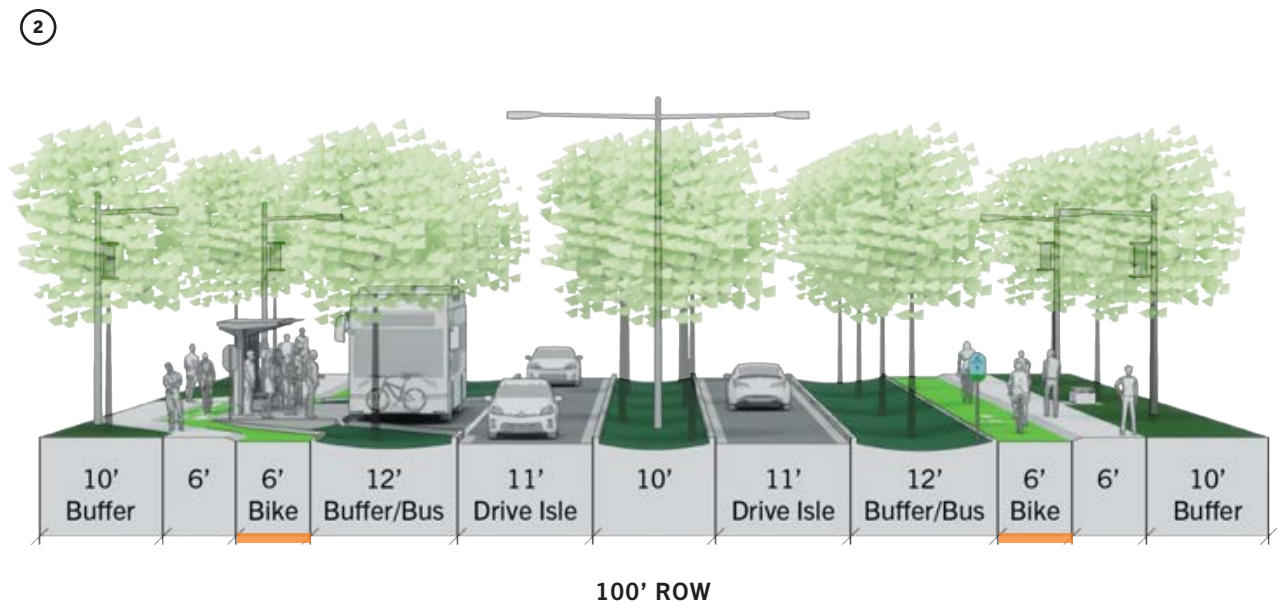
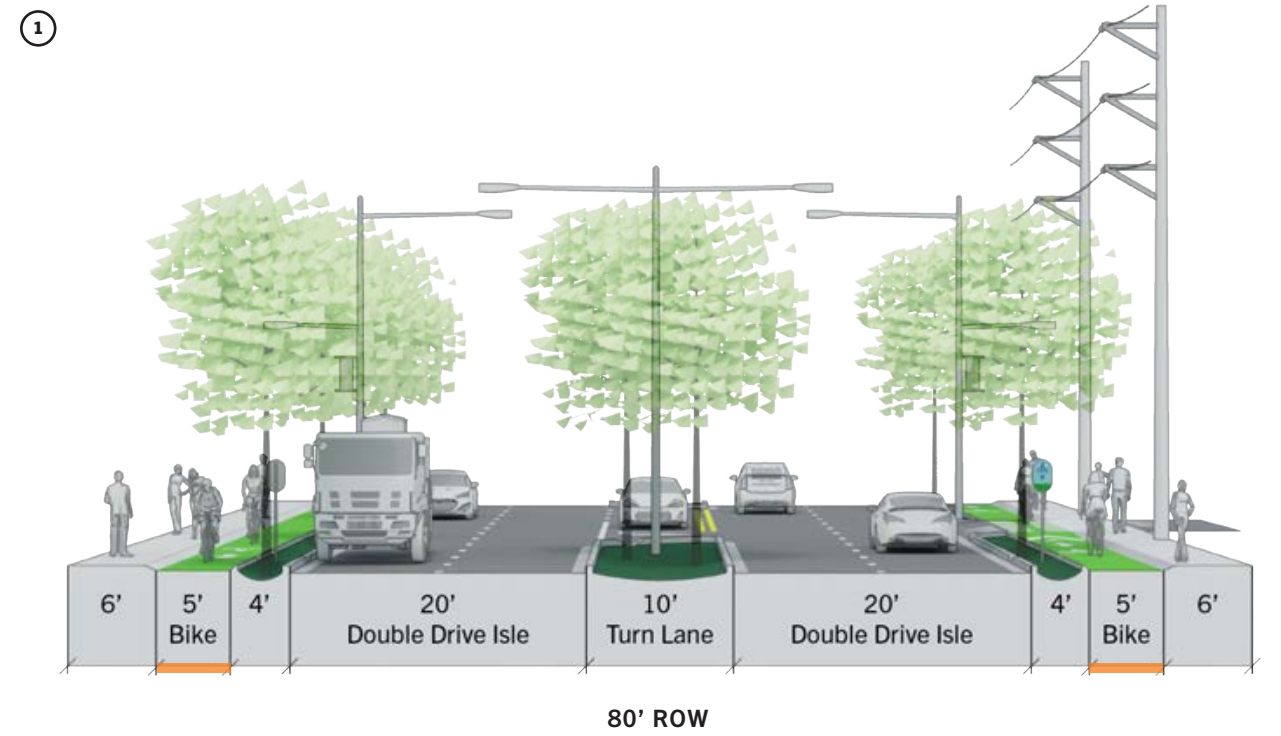

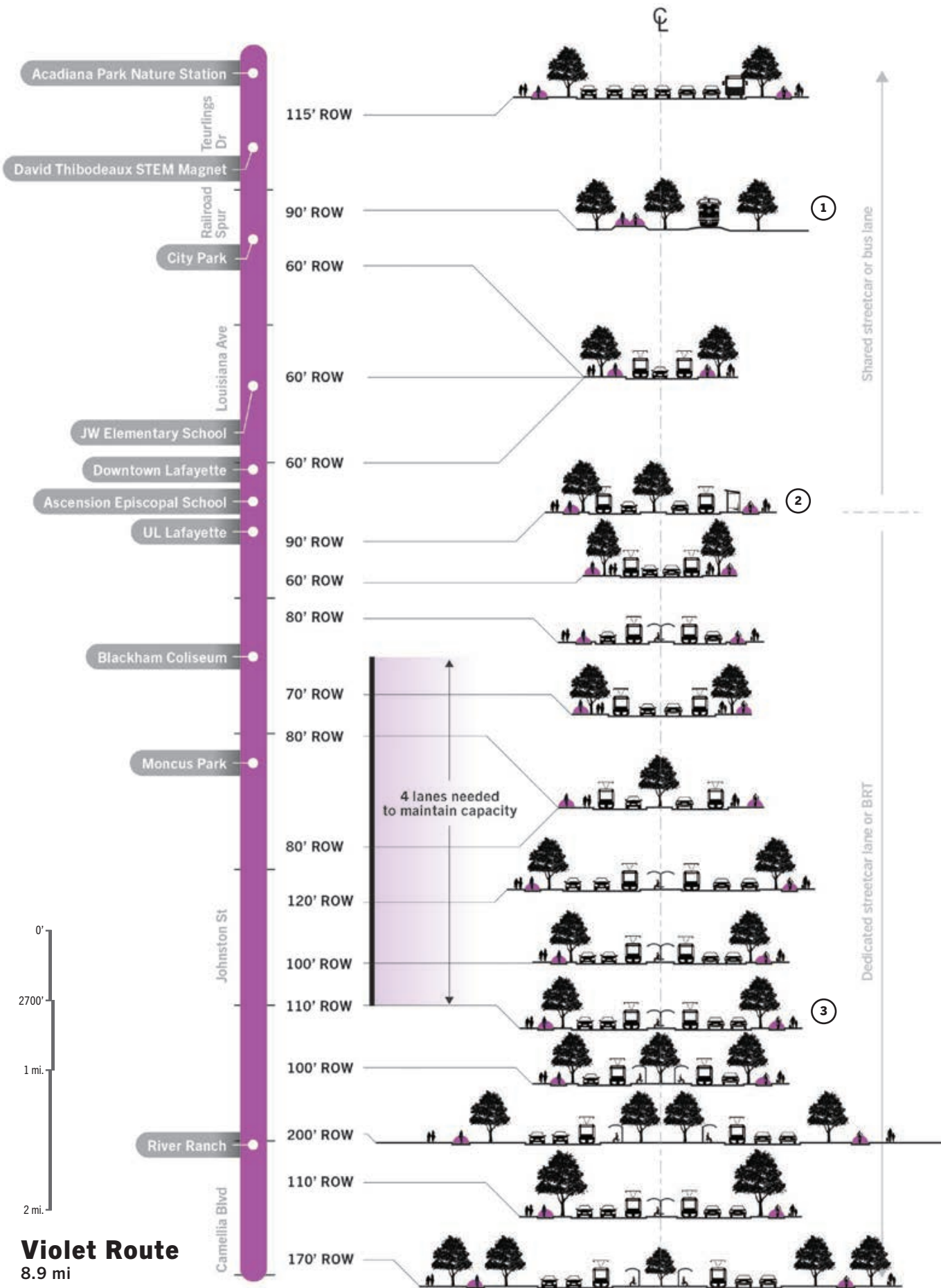

①

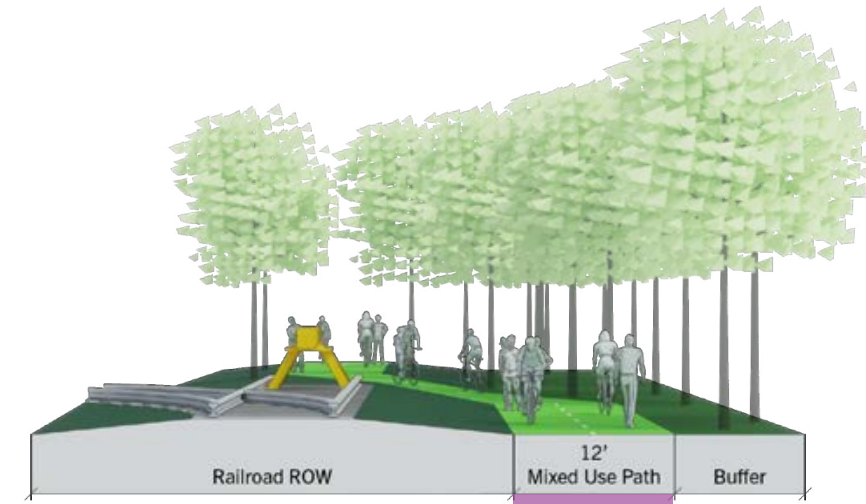

90' ROW

②

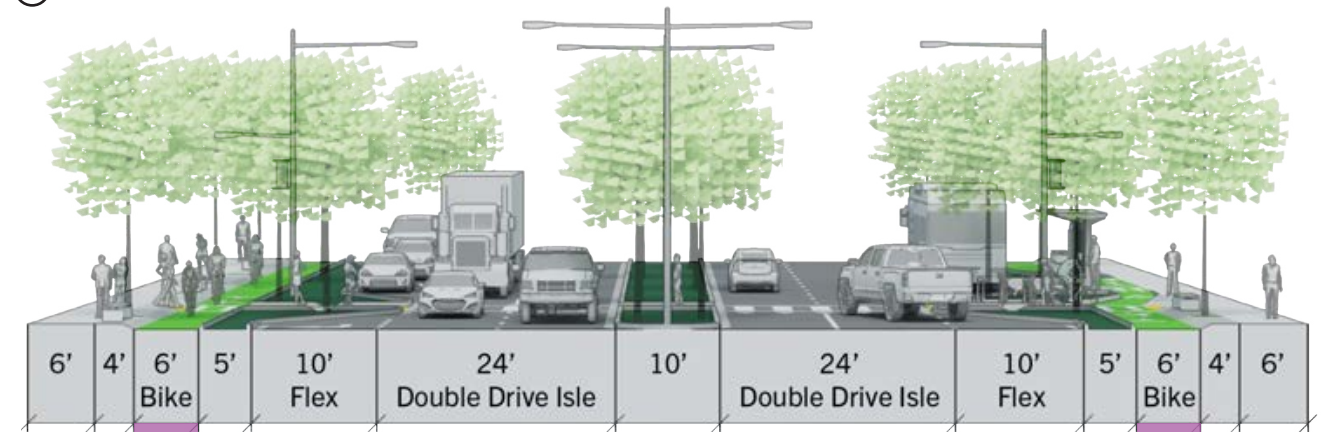

120' ROW

③

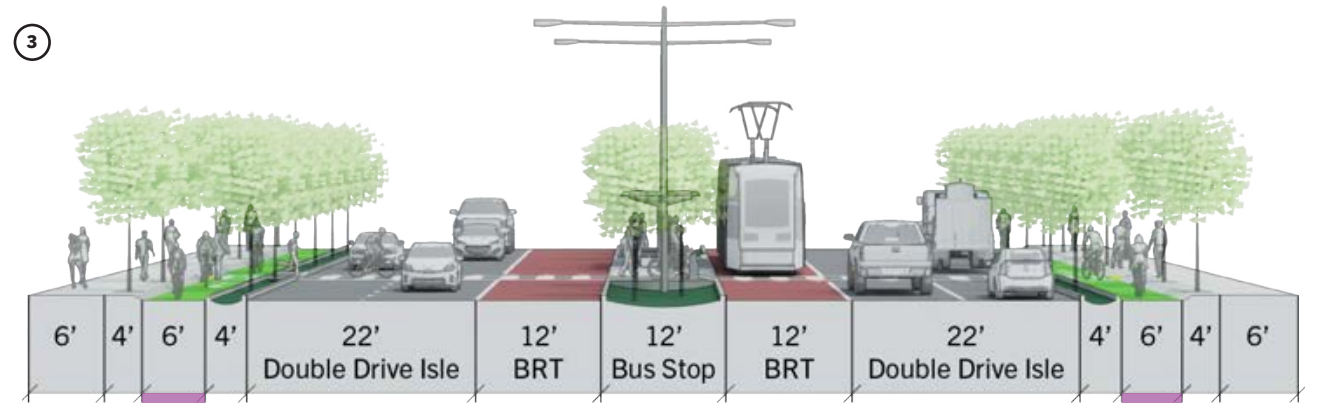

110' ROW

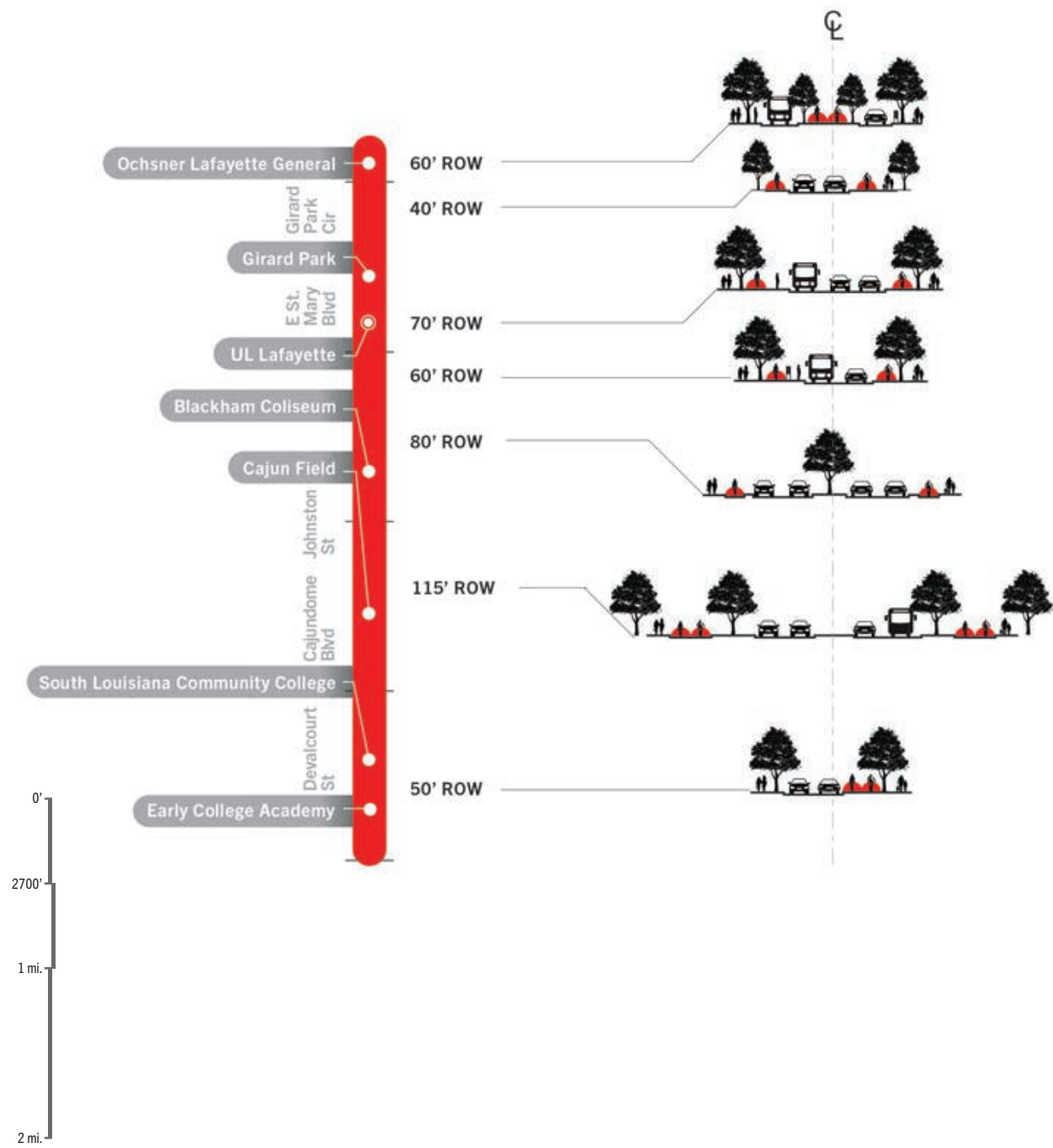

Rouge Route
4.1 mi

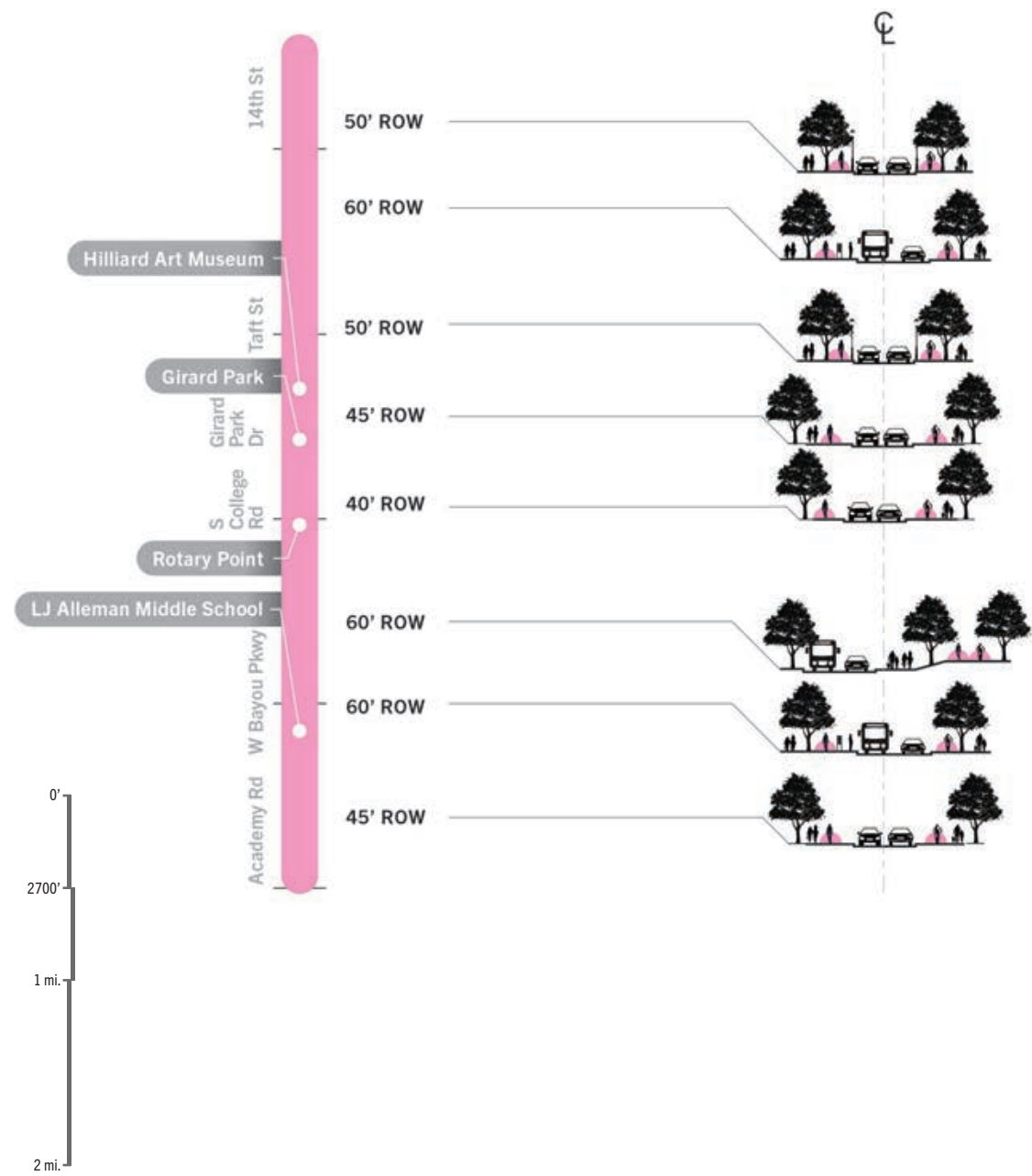

Rose Route
4.5 mi

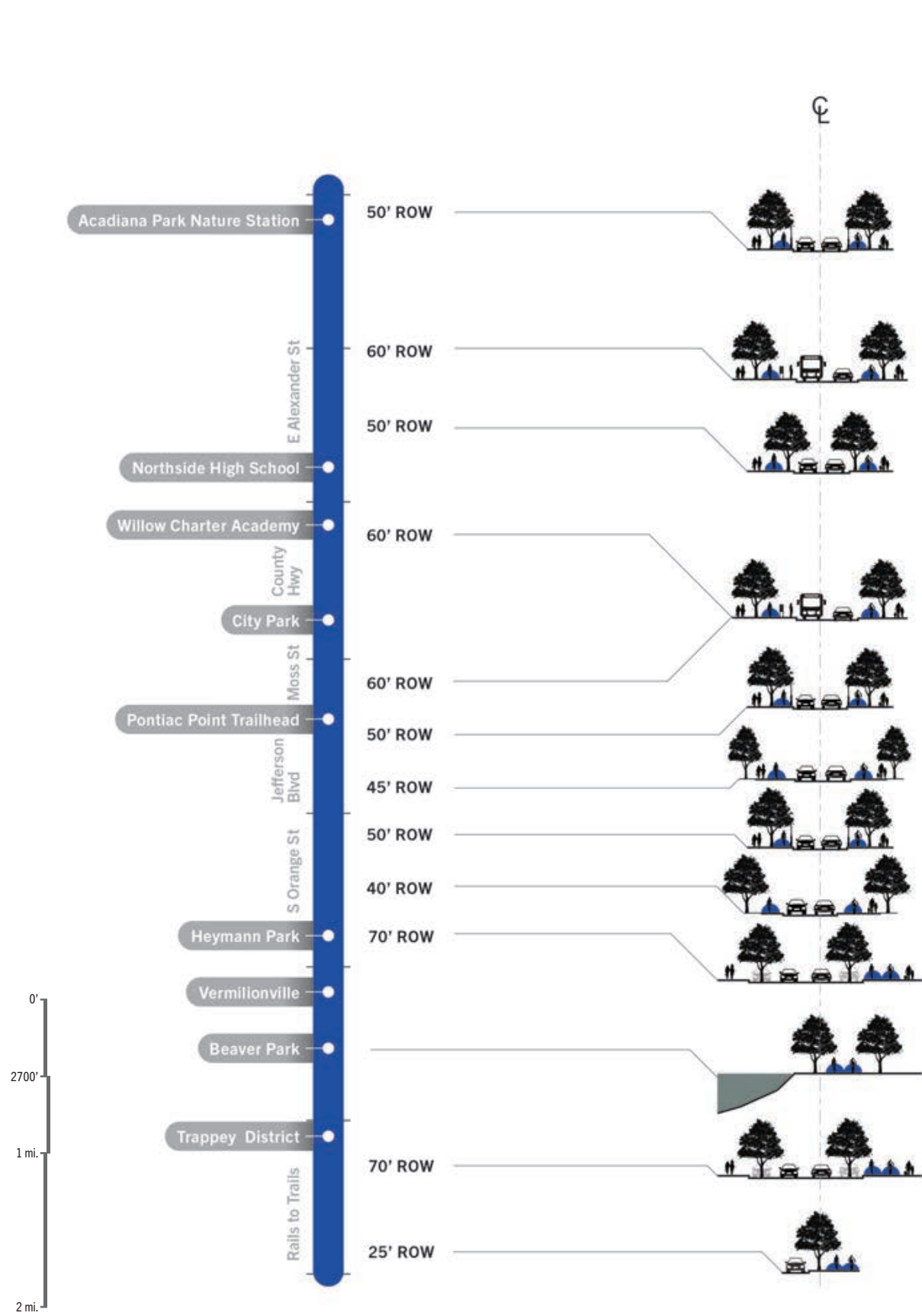

Bleu Route
6.1 mi

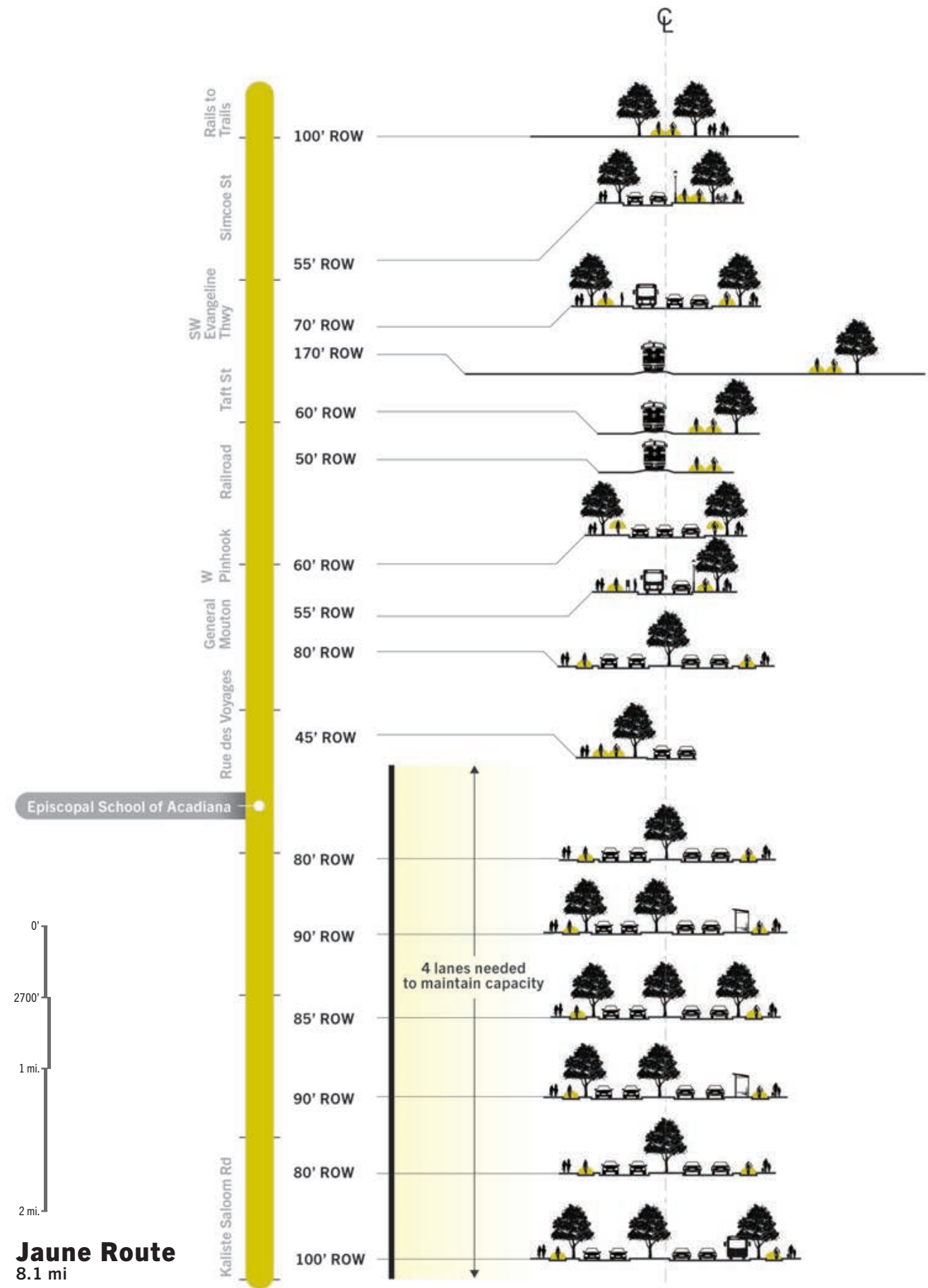

Jaune Route
8.1 mi

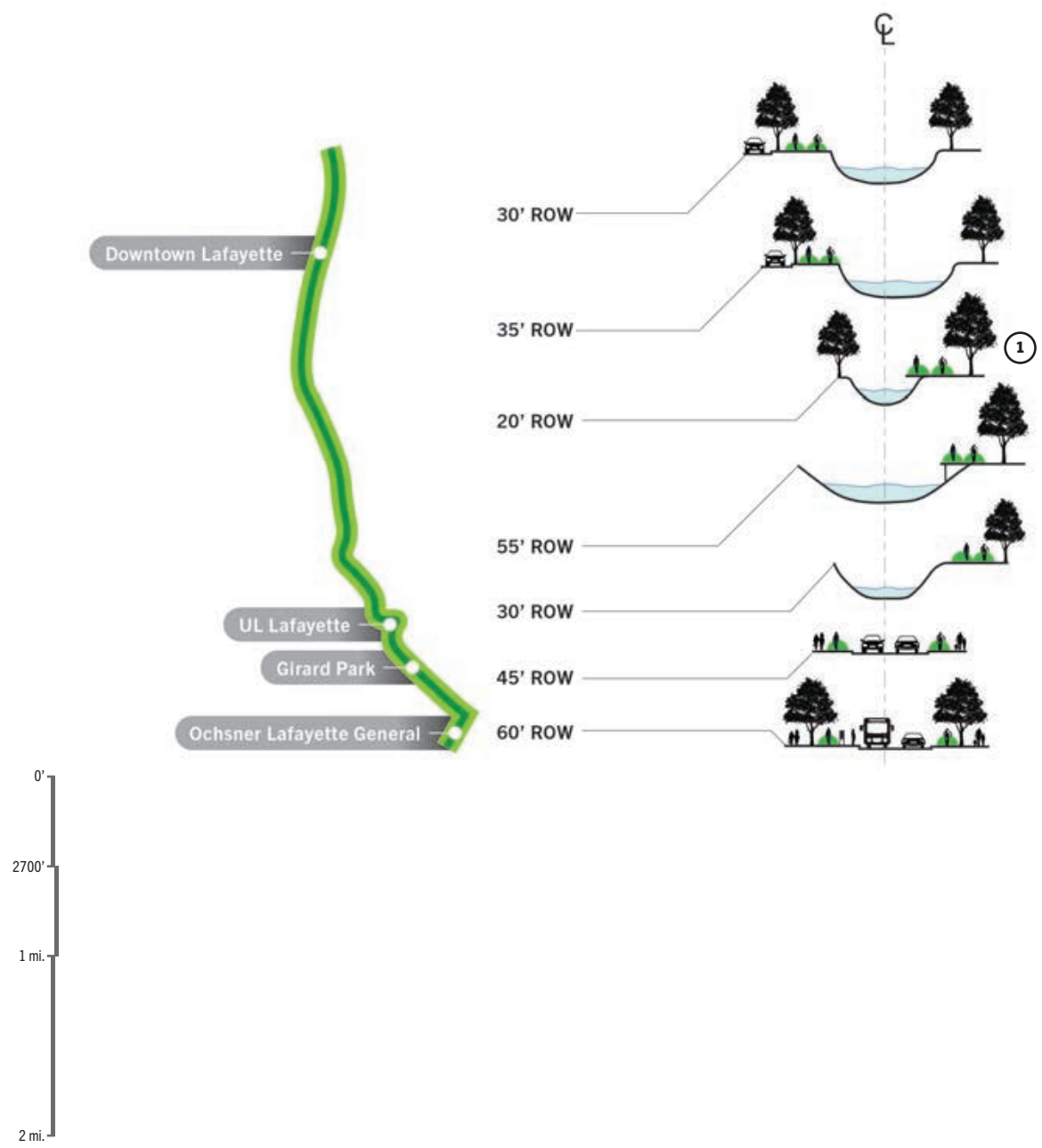

Coulee St. John, Recreational
2 mi

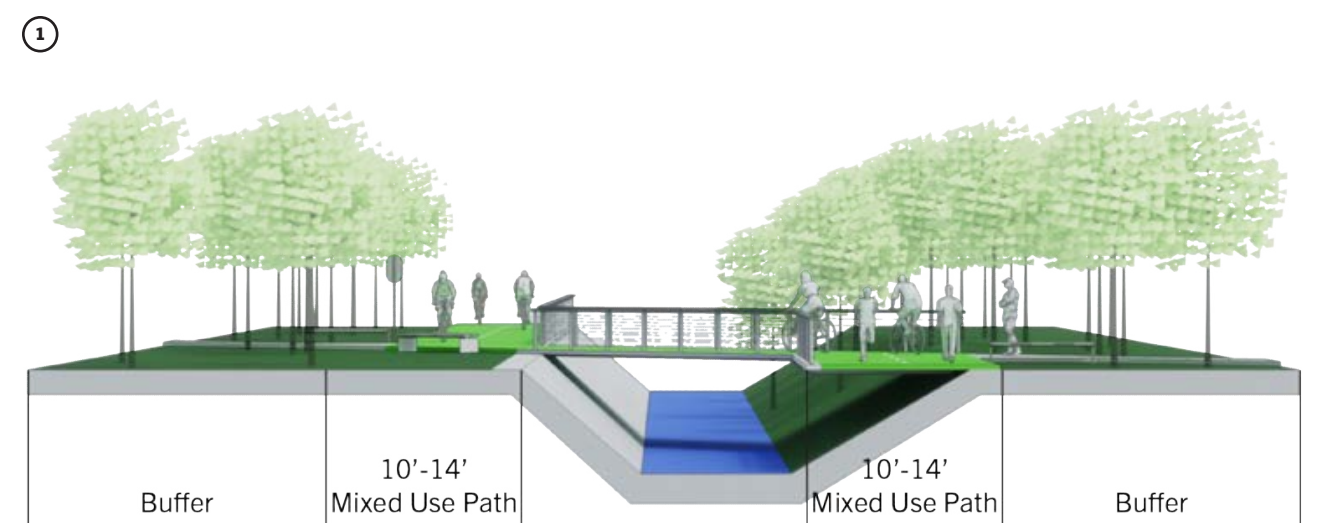

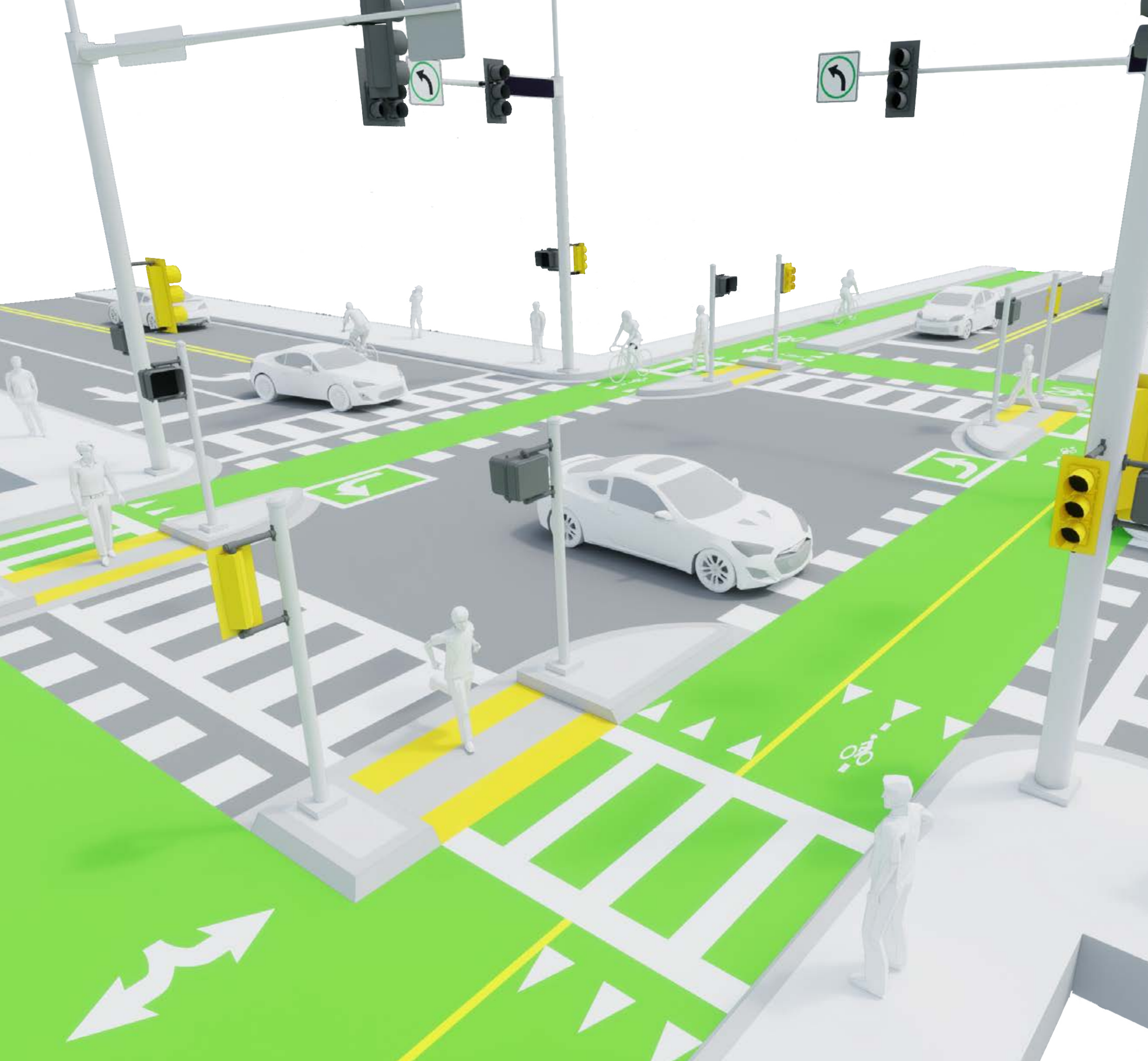

6

Street Design

In order to best accomplish the goals of Bicycle Lafayette it is important to demonstrate through a series of isometric diagrams some of the most common scenarios to implementing the Bicycle Lafayette system. The following chapter illustrates the building blocks to a complete bicycle network through various scales of street sections and intersection designs.

- 6.1 Street Typologies
- 6.2 Bicycle Paths at Bus Stop
- 6.3 Curb Details
- 6.4 Rainwater Management
- 6.5 Intersection Typologies

6.1 Street Typologies

The Bicycle Lafayette street design strategies incorporate feedback received from the public input process. The most popular typical road sections were those with the most separation of cyclists and pedestrians from the automobile. This chapter illustrates the main concepts developed through a series of different available right-of-way widths.

There are eight different typologies, meant to expand upon the sections found in [Chapter 5](#) of the document. These sections are shown in isometric (parallel projected drawing) diagrams in order to show changing situations along the proposed routes found in [Chapter 4](#). These start out with bicycle paths along roadways in varying sized right-of-way options. Elements of the plan are expanded upon, revealing more details. Beginning with a sixty foot right-of-way width in two variations and building up to a right-of-way width large enough to incorporate rapid mass transit systems like bus rapid transit (BRT) or streetcars.

Several typical isometric diagrams follow that demonstrate how bicycle paths are incorporated in areas away from roadways. These are along coulees (lo-

cal term for creeks) and either along existing railways or on abandoned rail line beds. The coulee isometric diagram suggests re-naturalizing coulees where right-of-way is easily available in order to maintain or improve drainage capacity while placing bicycle and walking paths along them.

Components to consider along typical bicycle network paths are included in this chapter such as lighting, rainwater management elements, bike trailheads, wayfinding signage, sidewalks, landscaping, electrical lines, bus stops, bridges, and rapid mass transit stops.

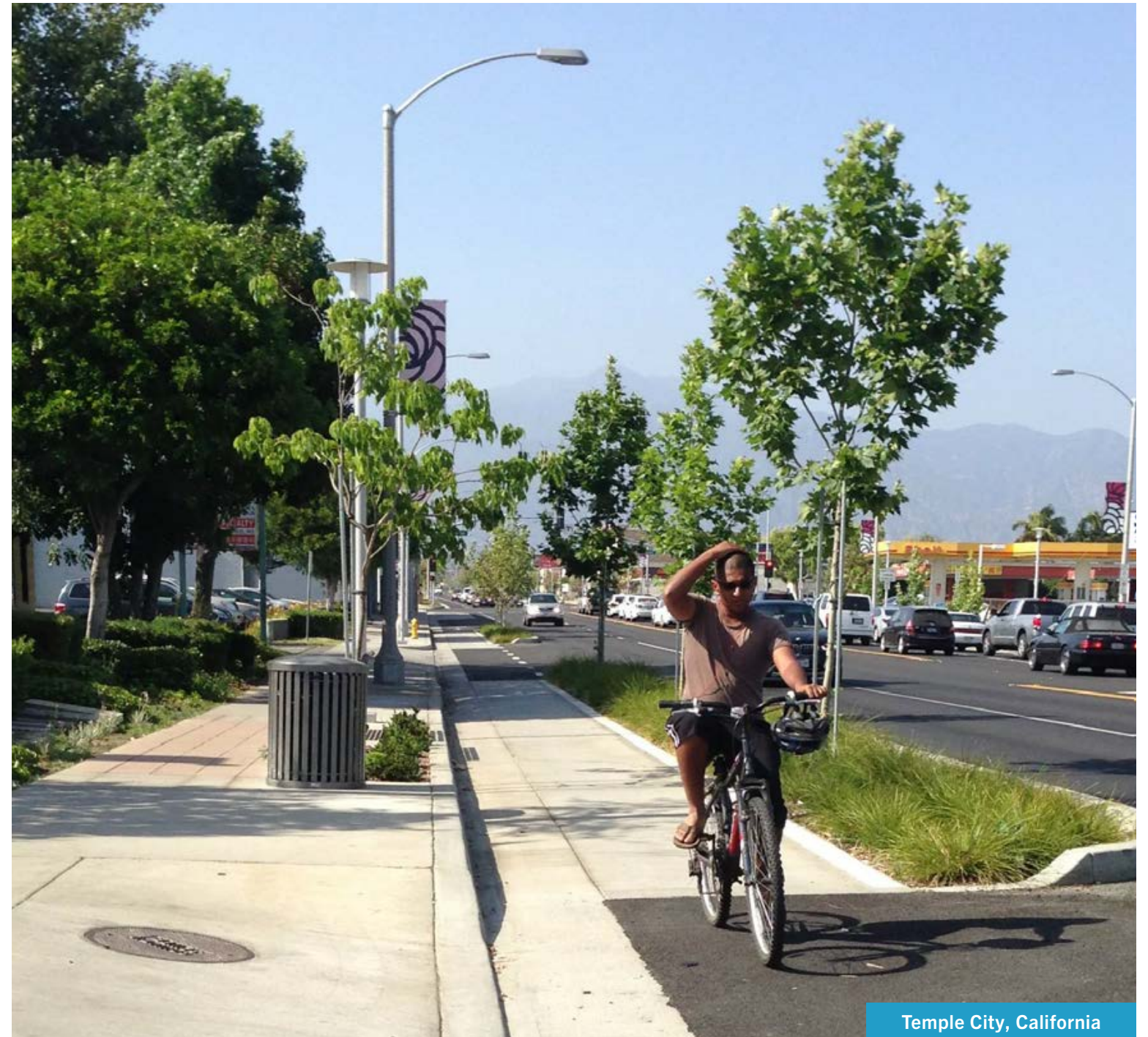

Temple City, California

6.1.2 60' ROW (A)

A typical street with sixty feet of right-of-way and a traffic count of less than 20,000 cars per day can be converted to two travel lanes for automobiles to provide room on the street for other modes of transportation and rainwater detention opportunities (Institute of Transportation Engineers, 2009).

- 1 One-way Bicycle Path**
Separated from the roadway with a small planted bioswale provides separation and a space for shade trees.
- 2 Bioswale Median**
By giving back some of the public right-of-way to rainwater management the planted swale can also give more shade to the roadway, decreasing the ambient temperature during hot months.
- 3 Sidewalk**
At least six feet wide made in concrete and raised one inch above bicycle path with mountable curb (see detail in Section 6.3).

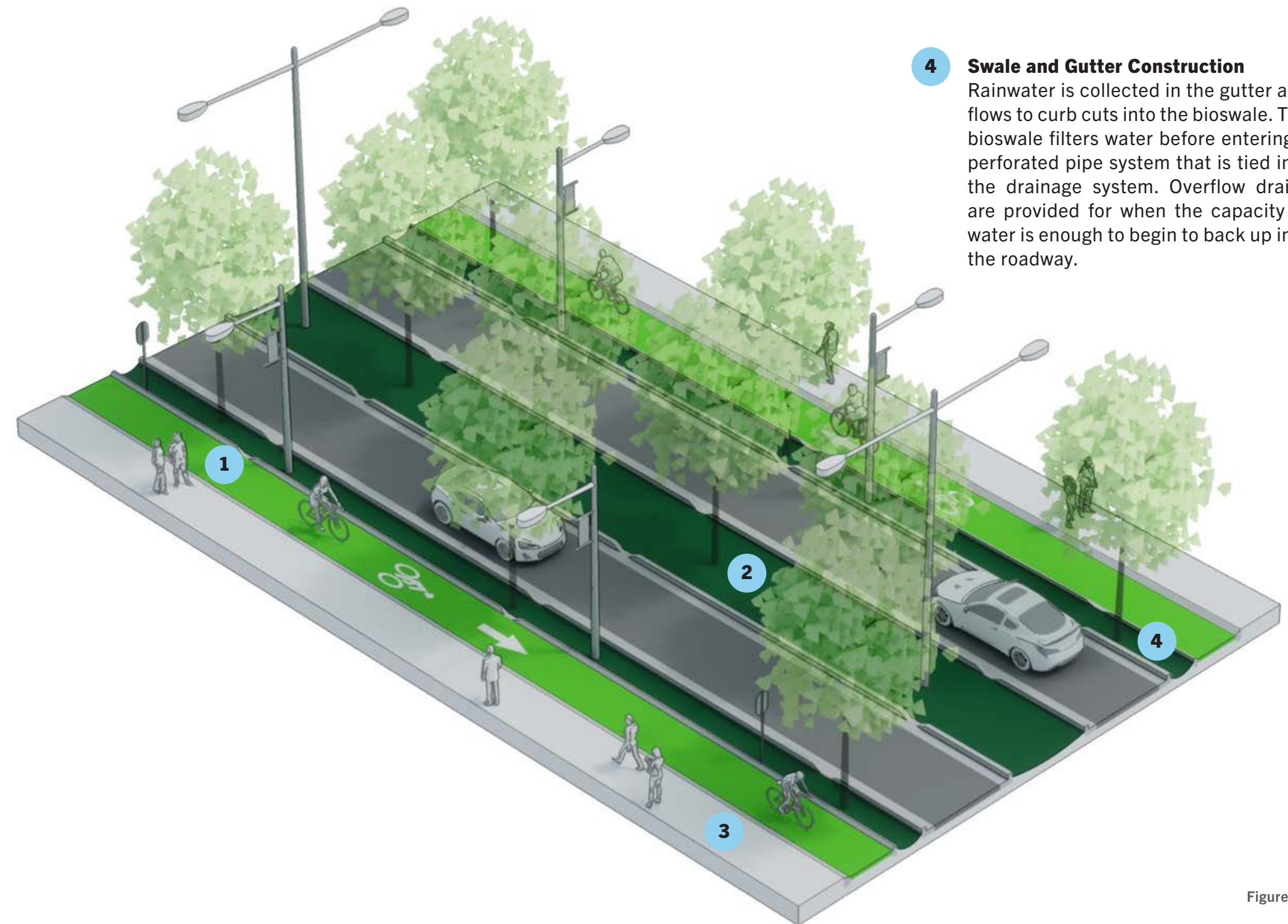

- 4 Swale and Gutter Construction**
Rainwater is collected in the gutter and flows to curb cuts into the bioswale. The bioswale filters water before entering a perforated pipe system that is tied into the drainage system. Overflow drains are provided for when the capacity of water is enough to begin to back up into the roadway.

Figure 6A

6.1.3 60' ROW (B)

This isometric example is specific to Coolidge Street in the Oil Center segment of the Véloop. The concept of a two-way bicycle path can be also used in other situations.

1 Trailhead

Trailheads are great ways to provide more access to the Bicycle Lafayette network. Bike share systems as well as amenities such as drinking water and wayfinding totems all lend themselves towards a more accessible, safer, and more comfortable network.

2 Two-way Bicycle Path

Bidirectional bicycle paths allow for some consolidation of width required. Striping is important to better indicate the two-way section.

3 Bioswale

By giving back some of the public right-of-way to rainwater management the planted swale can also give more shade to the roadway, decreasing the ambient temperature during hot months (see detail in Section 6.4).

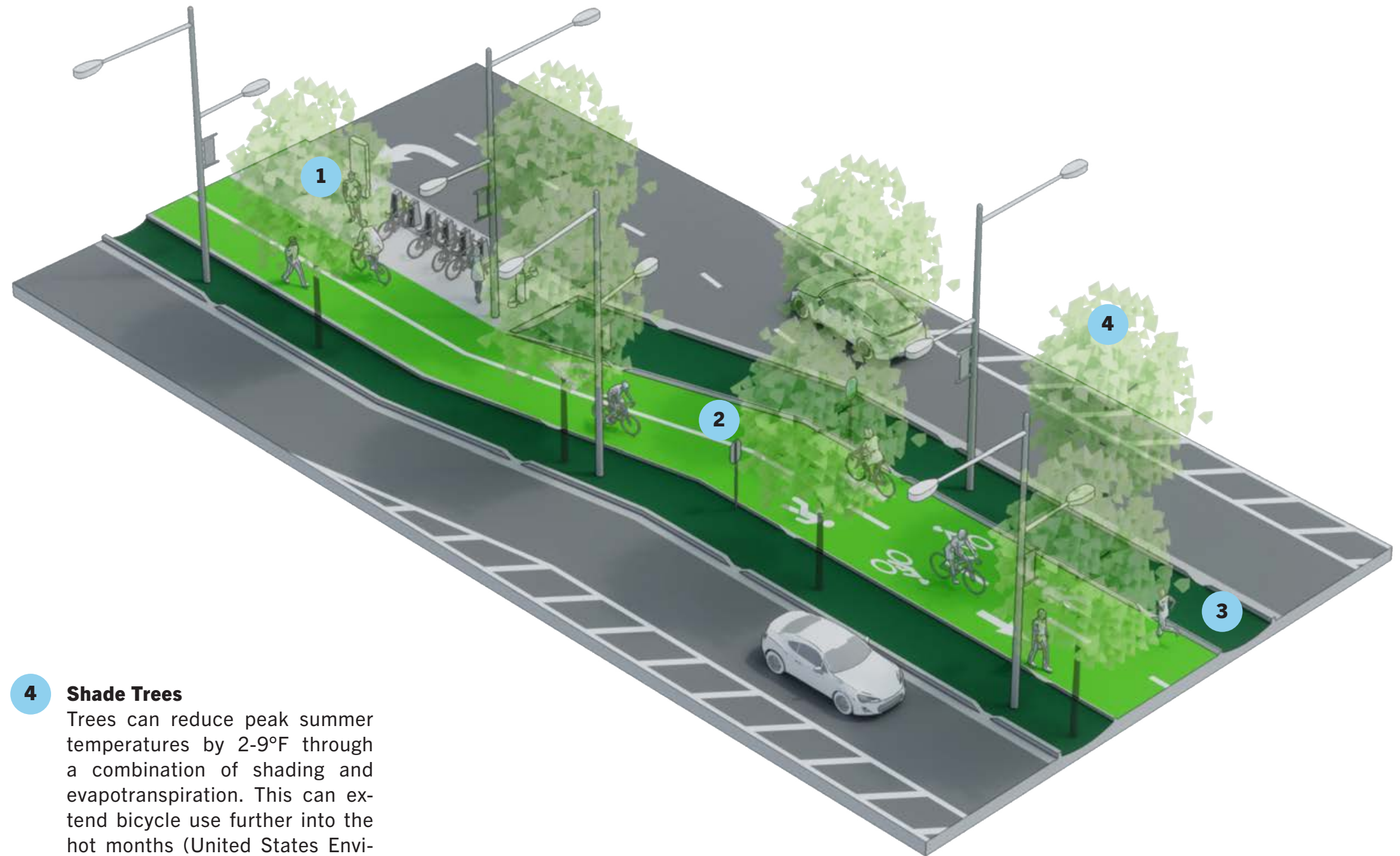

4 Shade Trees

Trees can reduce peak summer temperatures by 2-9°F through a combination of shading and evapotranspiration. This can extend bicycle use further into the hot months (United States Environmental Protection Agency).

Figure 6B

6.1.4 80' ROW

With an eighty feet wide right-of-way enough space is provided to maintain traffic capacity where traffic counts are above 20,000 cars per day and still have enough space to include bioswales with shade trees to shade bicyclists and pedestrians (Institute of Transportation Engineers, 2009).

- 1 Pedestrian and Bike Striping**
Maintain zebra striping at intersections for visibility to motorists. A raised table at these points further reduces vehicular speeds and increases safety. Bicyclists and pedestrians remain on their level rather than going down to the vehicular level (NACTO).
- 2 Turn Lane**
When needed to maintain traffic capacity otherwise median more appropriate to maintain detention and shade opportunities.
- 3 Lighting**
A high-low luminaire design with LEDs that are dark sky compliant. Where street medians are possible a higher double luminaire is appropriate with shorter pedestrian and bicycle luminaire in the buffer zone.

- 4 Transmission Electrical Line**
It is encouraged to place all local electrical lines underground while constructing the Bicycle Lafayette network however where transmission electrical lines prove too costly to bury they should be placed on the edge of the right-of-way or outside of the right-of-way in a utility servitude on steel poles with lines stacked rather than on a T.

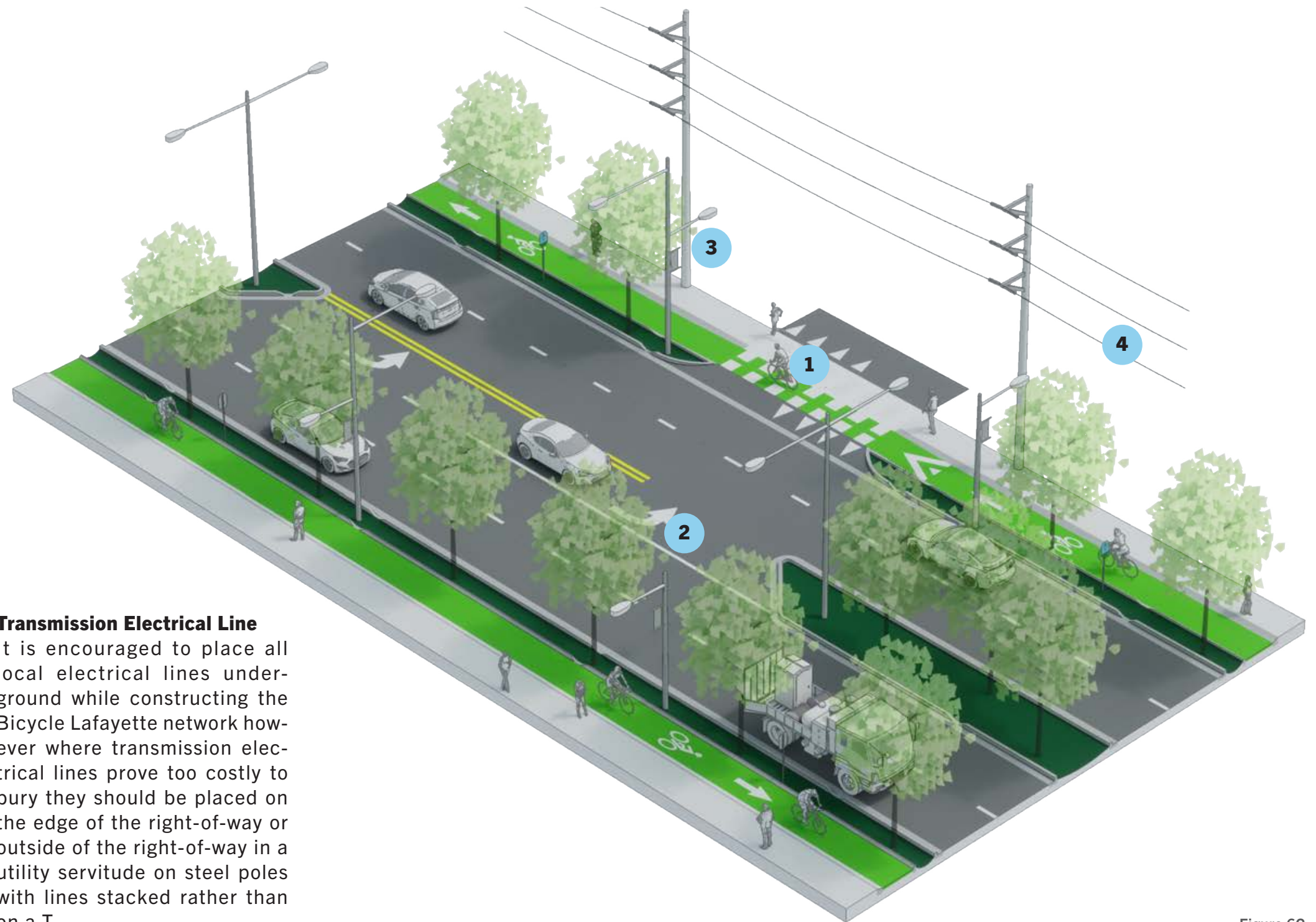
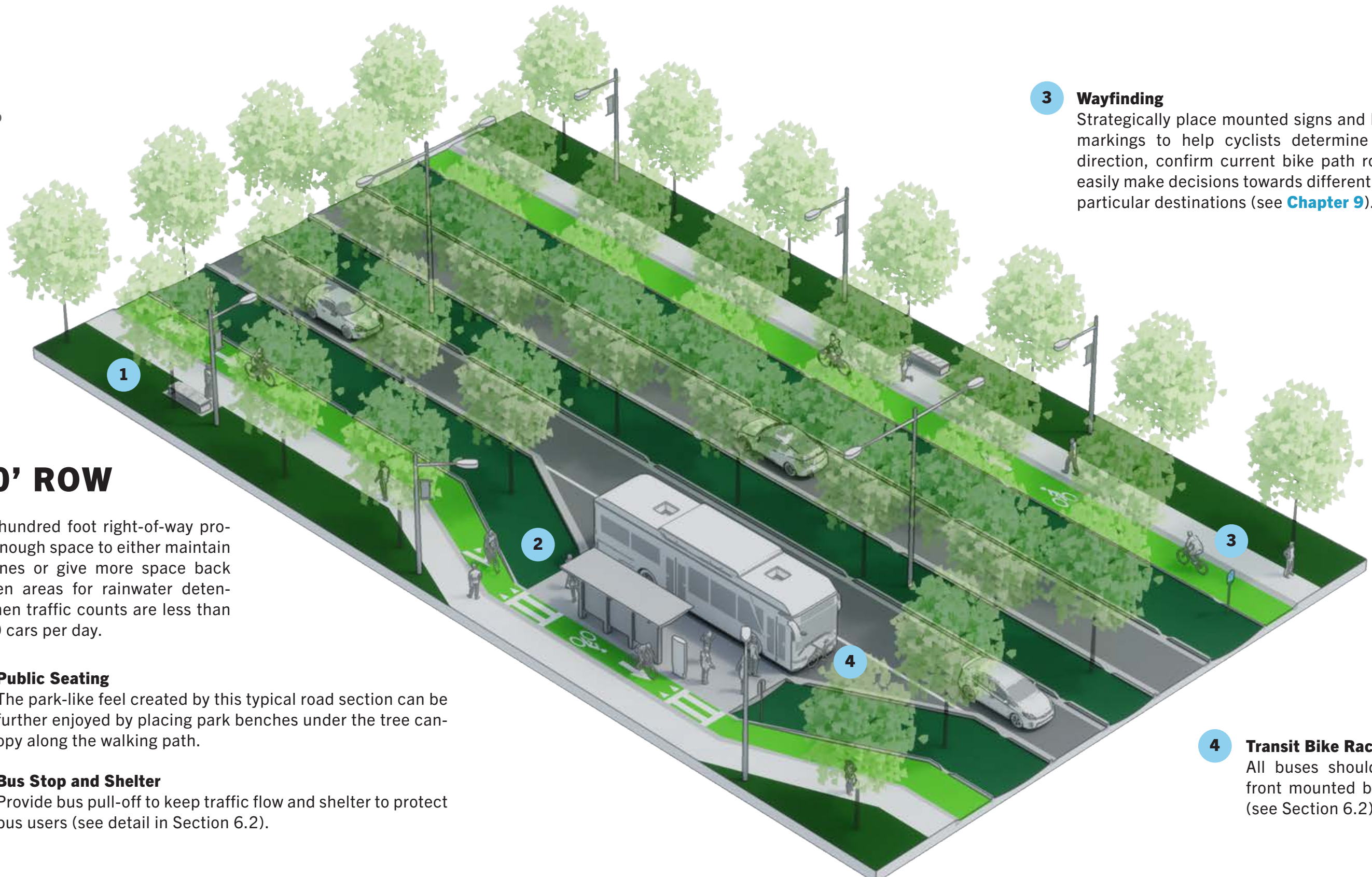

Figure 6C

Figure 6D



6.1.5 100' ROW

A one hundred foot right-of-way provides enough space to either maintain four lanes or give more space back to green areas for rainwater detention when traffic counts are less than 20,000 cars per day.

- 1 Public Seating**
The park-like feel created by this typical road section can be further enjoyed by placing park benches under the tree canopy along the walking path.
- 2 Bus Stop and Shelter**
Provide bus pull-off to keep traffic flow and shelter to protect bus users (see detail in Section 6.2).

- 3 Wayfinding**
Strategically place mounted signs and bike path markings to help cyclists determine pathway direction, confirm current bike path route, and easily make decisions towards different routes or particular destinations (see [Chapter 9](#)).

- 4 Transit Bike Rack**
All buses should feature front mounted bike racks (see Section 6.2).

6.1.6 120' ROW

At this right-of-way width four lane boulevards are possible with parallel parking options, bus stop pull-offs and trailheads.

- 1 Parallel Parking**
Provide where zoning is Mixed-Use Neighborhood (MN) or Commercial-Mixed (CM) when right-of-way width is available and traffic counts do not constitute additional lanes.
- 2 Pedestrian Crossing**
Locate near bus stops and provide area for primary or secondary trailhead amenities. Where lower speeds are desired, provide speed tables at pedestrian level.

- 3 Trailhead at Crossing**
(See [Chapter 8](#))
- 4 Curb Cut**
Provide for rainwater to enter bioswale (see detail in Section 6.3).

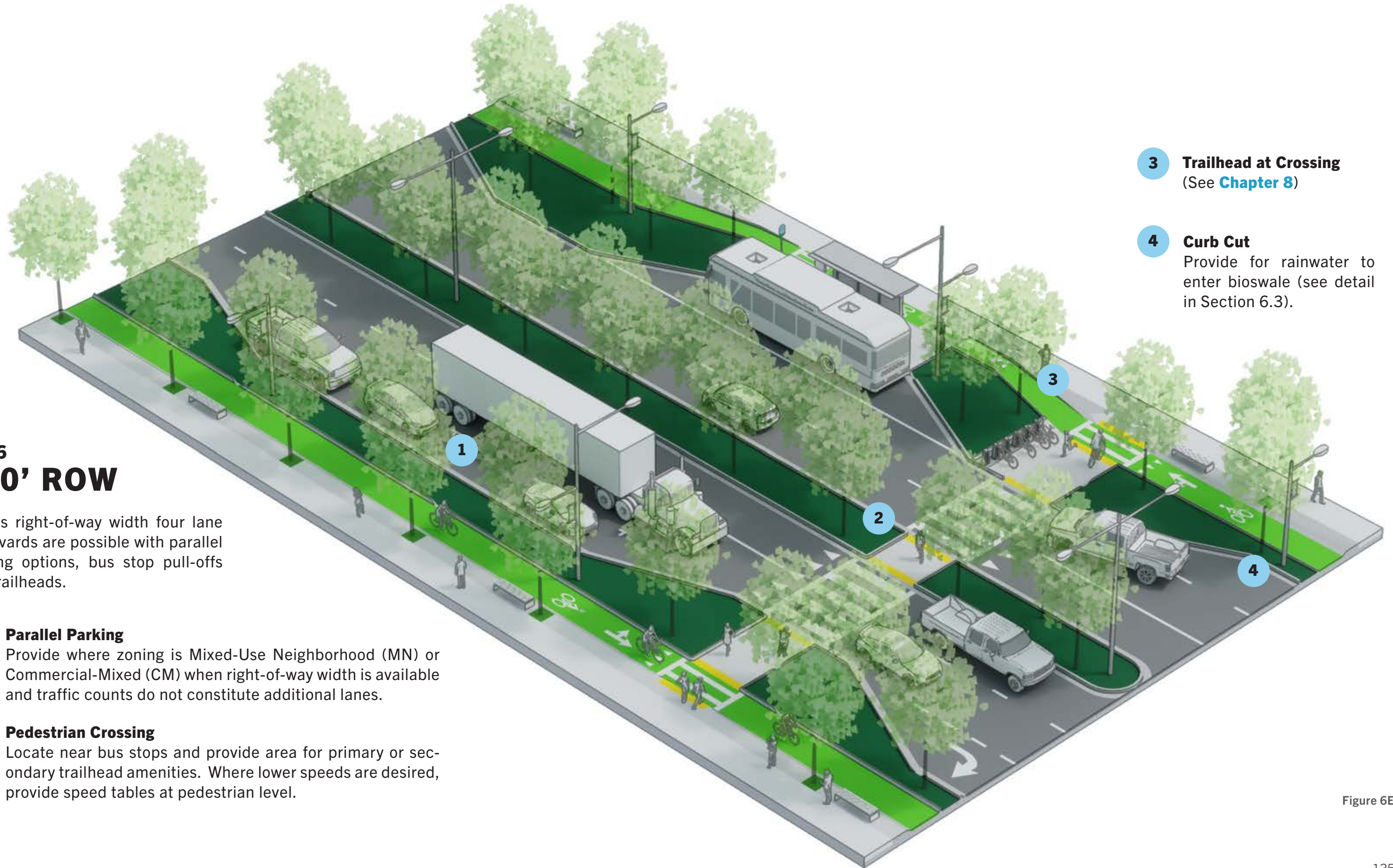
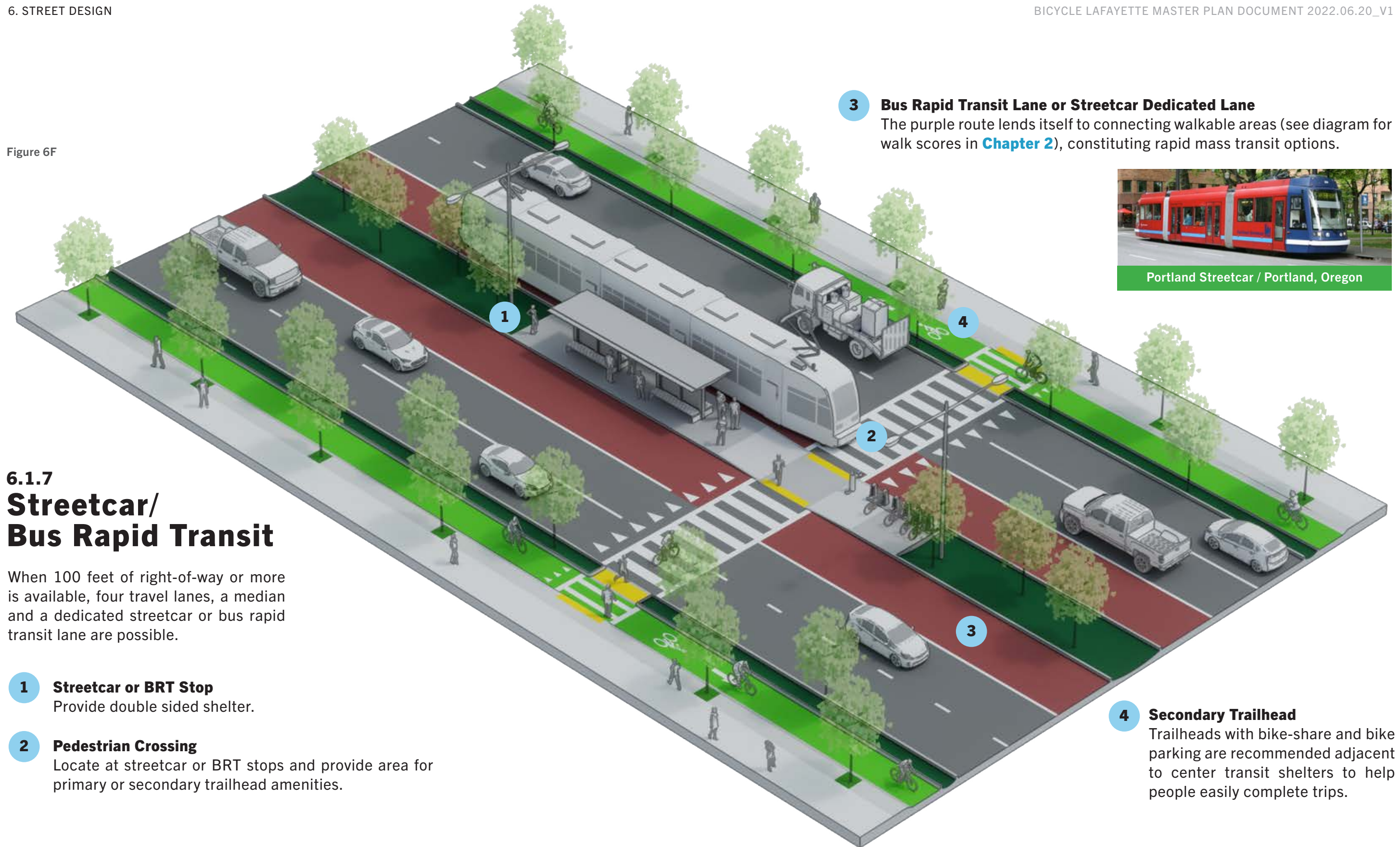

Figure 6E

Figure 6F



3 Bus Rapid Transit Lane or Streetcar Dedicated Lane
 The purple route lends itself to connecting walkable areas (see diagram for walk scores in **Chapter 2**), constituting rapid mass transit options.



6.1.7 Streetcar/ Bus Rapid Transit

When 100 feet of right-of-way or more is available, four travel lanes, a median and a dedicated streetcar or bus rapid transit lane are possible.

- 1 Streetcar or BRT Stop**
Provide double sided shelter.
- 2 Pedestrian Crossing**
Locate at streetcar or BRT stops and provide area for primary or secondary trailhead amenities.

- 4 Secondary Trailhead**
Trailheads with bike-share and bike parking are recommended adjacent to center transit shelters to help people easily complete trips.

6.1.8 Rails to Trails

North of Downtown, specifically on the Orange Route, there are opportunities for converting the abandoned rail bed into multi-model trails. This route could eventually connect more regionally to cities north of Lafayette. Carencro, Sunset, Opelousas and Washington all contain this same abandoned railroad. The history of the railroad is evident by street names in these areas such as Butcher Switch Road, Gloria Switch Road and Flag Station Road.

**1 Abandoned Rail ROW
Converted to Bicycle Path**

These paths offer opportunities for shared uses such as with joggers and walkers. They also can have meandering dedicated equestrian paths.

2 South Oriented Shade Trees

Provide shade trees to the south and south-west of the trail in order to cool temperatures during the warm months.

3 Trails with Rails

Where active rail (from Trappey to Downtown) and rail spurs (northwest of Downtown to the Acadiana Park Nature Station) bicycle and shared-use paths opportunities exist.

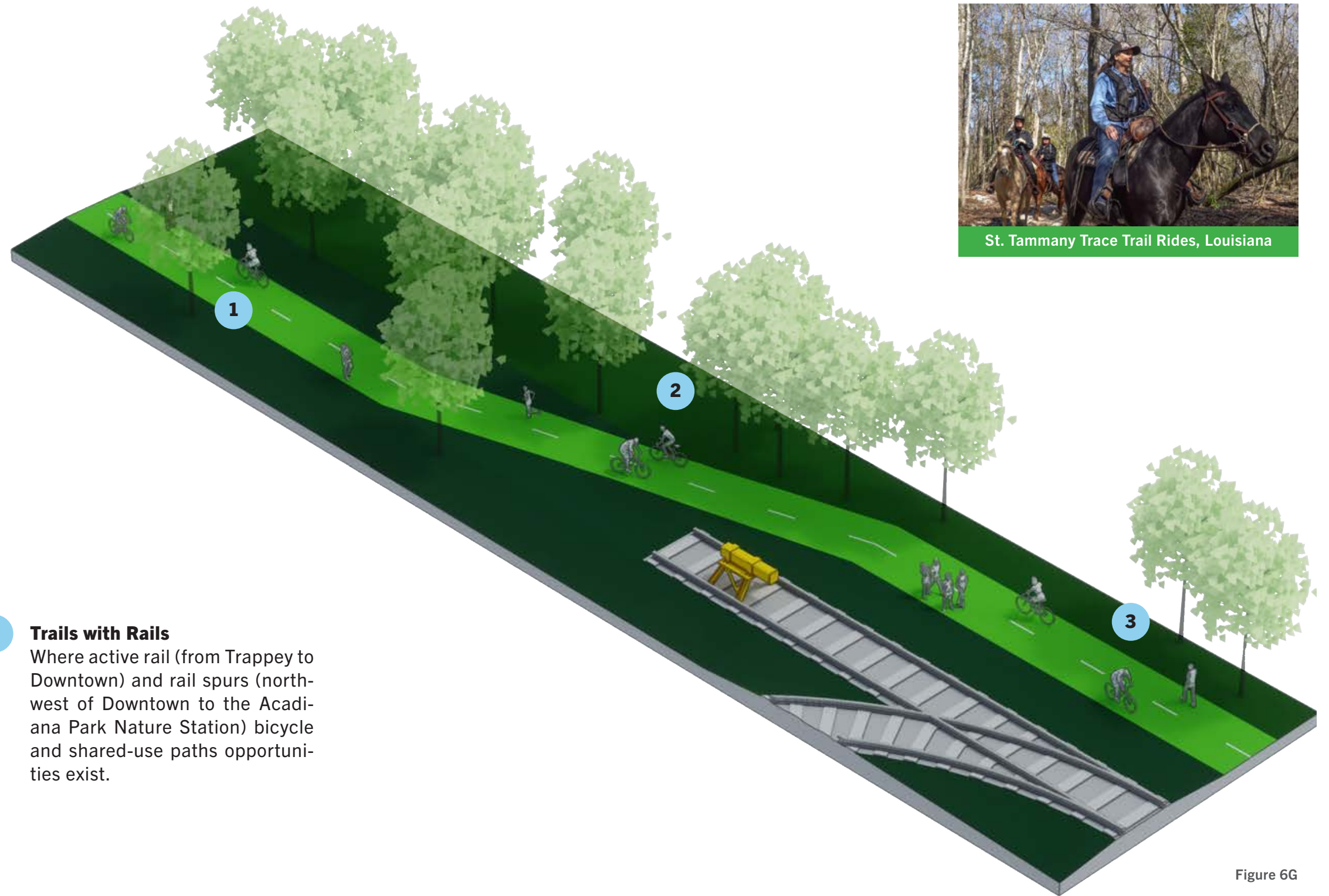

St. Tammany Trace Trail Rides, Louisiana

Figure 6G

6.1.9 Coulee Routes

Several coulees in Lafayette provide opportunities for bicycle and pedestrian paths, further separating routes from automobiles.

- 1 Naturalized Coulee Bank**
When enough right-of-way or public lands are available along concreted coulees enough space should be provided for the ability to naturalize coulees however maintain or improve rainwater capacity through widening the waterway.
- 2 Pedestrian and Bike Bridge**
A shared-use path can be provided at opportune moments along coulees in order to better connect neighborhoods and allow multiple neighborhoods to access the Bicycle Lafayette network.
- 3 Path Along Existing Concrete Bank**
Where not enough right-of-way, or ability to purchase additional right-of-way, exists and the need for continuity of bicycle paths, paths could cantilever over concreted coulee sections but should be designed to not negatively impact the flow of rainwater. Naturalized on the opposite side makes coulee feel more recreational.
- 4 South Oriented Trees**
Trees are important in Lafayette’s climate in order to extend the time periods where bicyclists are comfortable. Consideration should be given to existing trees as well and best when located on southern exposure to maintain shade for path users.

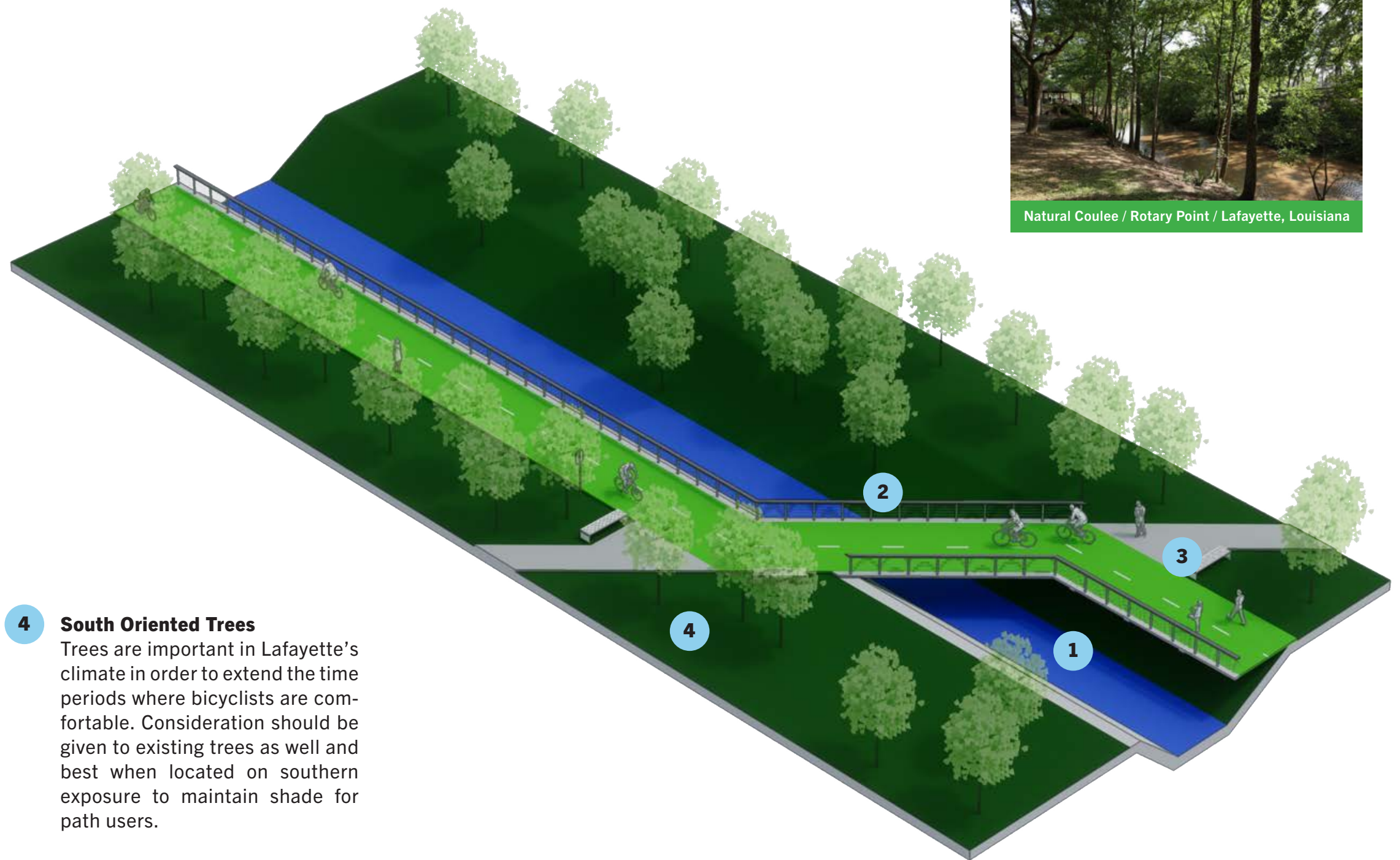

Figure 6H

6.2 Bicycle Paths at Bus Stops

Multimodal transportation is important for a trip continuum and ultimately can determine whether or not someone decides to bike as a way to get to their destination.

- 1 Bus Stop Shelter**
Bicycle paths should set back further from the roadway in order to provide enough space for bus stop shelters. This also allows bicyclist to maintain circulation when buses are loading.
- 2 Wayfinding Totem**
Totems should present cyclists with large maps for orientation and information on routes.
- 3 Zebra Stripe for Pedestrians**
In order to maintain the best visibility of pedestrians passing thought bicycle paths, striping should be provided. Zebra stripes with yield strips is recommended.
- 4 Directional Striping**
To maintain safety in passing bicyclists clarity of direction is important and should be reinforced through both signage and pavement striping.

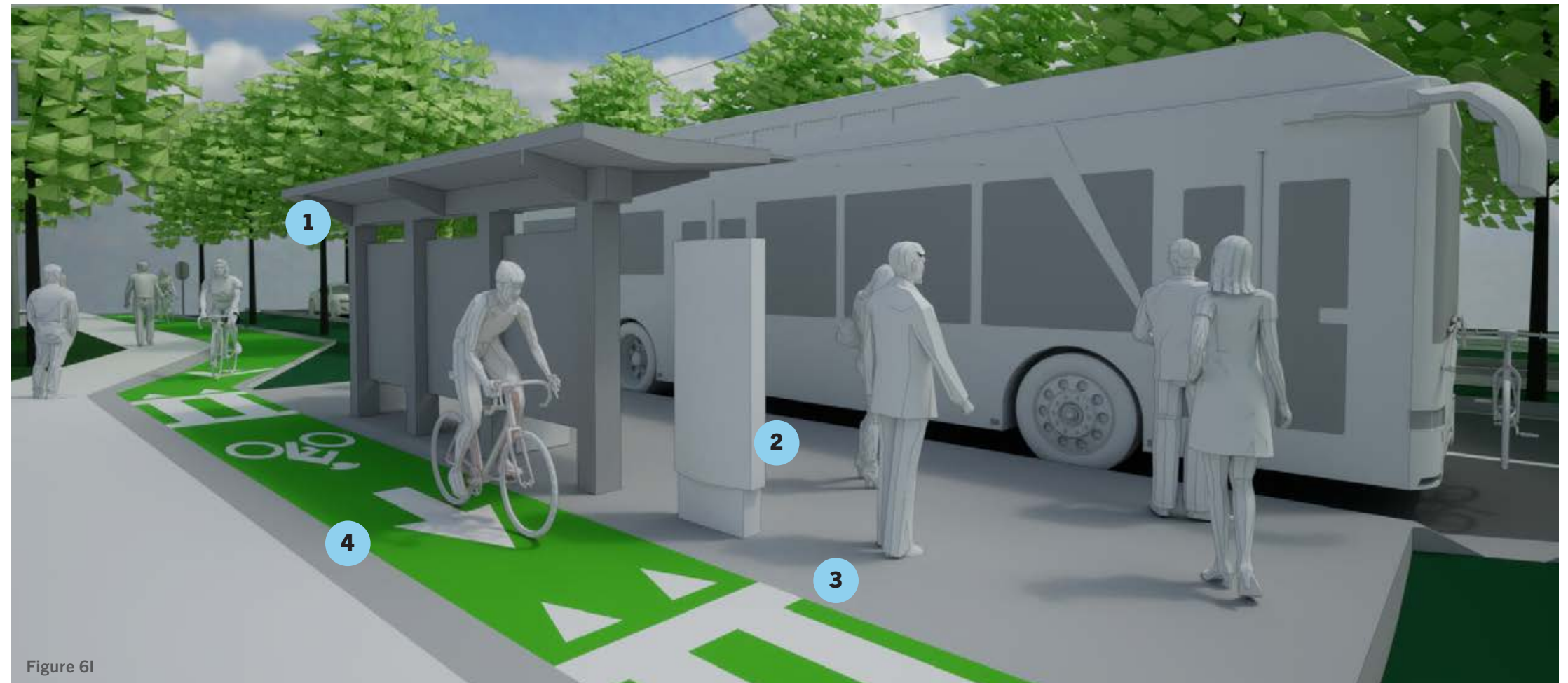

Figure 6I



6.3 Curb Details

Curbs can offer opportunities of separation and comfortability between the different modes of transportation. When designing the street consideration should be given to each mode and the ease of mounting the curb versus the protection needed. For instance, a bicycle path should not be sandwiched with two non-mountable curbs in case the bicyclist needs to move off of the path to avoid collisions.

- 1 Mountable Curb**
A good option for separating the asphalt bicycle path from the concrete walking path.
- 2 Beveled Curb**
Can be used as a protective barrier or to keep bicyclist from riding into bioswales. Also collects rain water to send to curb cuts.
- 3 Vertical Curb and Gutter**
A common system seen on roadways, helps to keep motorists from driving into bioswales or into bicyclist or pedestrian paths.
- 4 Curb Cut**
With the bioswale rainwater system, curb cuts send water into the bioswale system rather than conventional gutter inlets.



Figure 6J

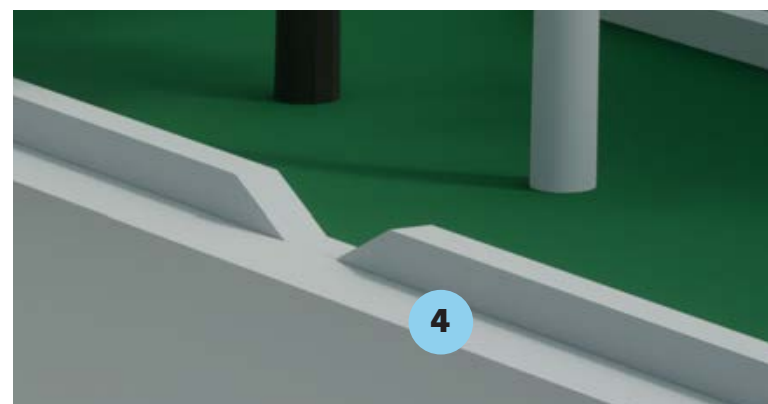
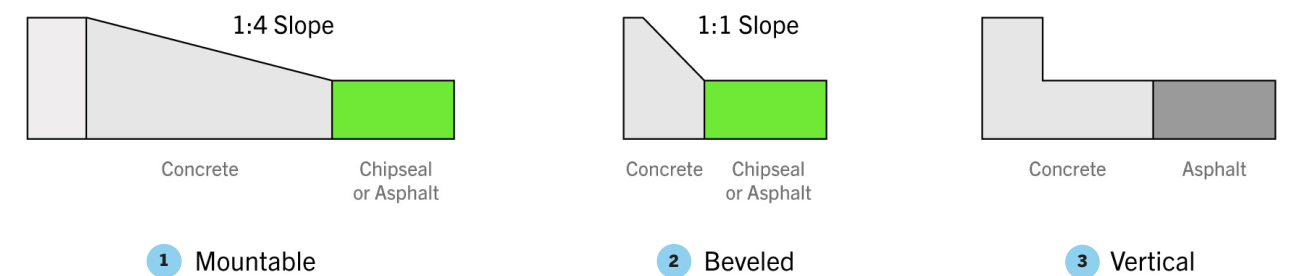
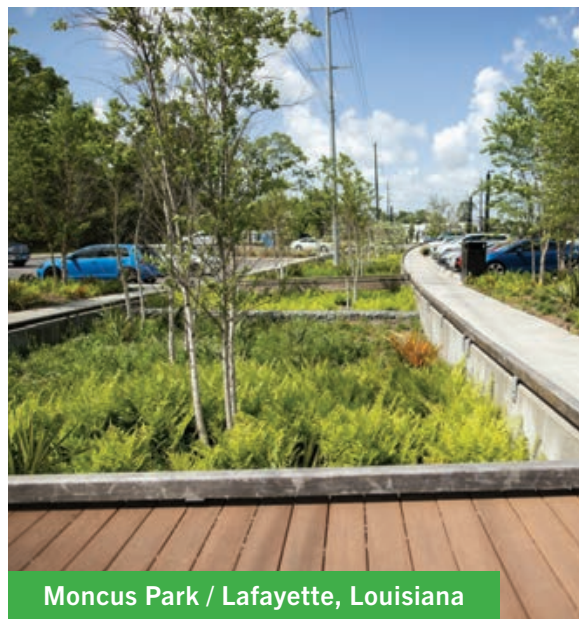

Figure 6K



6.4 Rainwater Management

Streets can serve as more than a place for people to travel by foot, bike or automobile. Since paved areas increase rainwater runoff volumes, the street section can make up by the use of a bioswale system. Rainwater management is very important in Lafayette’s climate, especially given climate change and increases in the number of major rain events.



Moncus Park / Lafayette, Louisiana

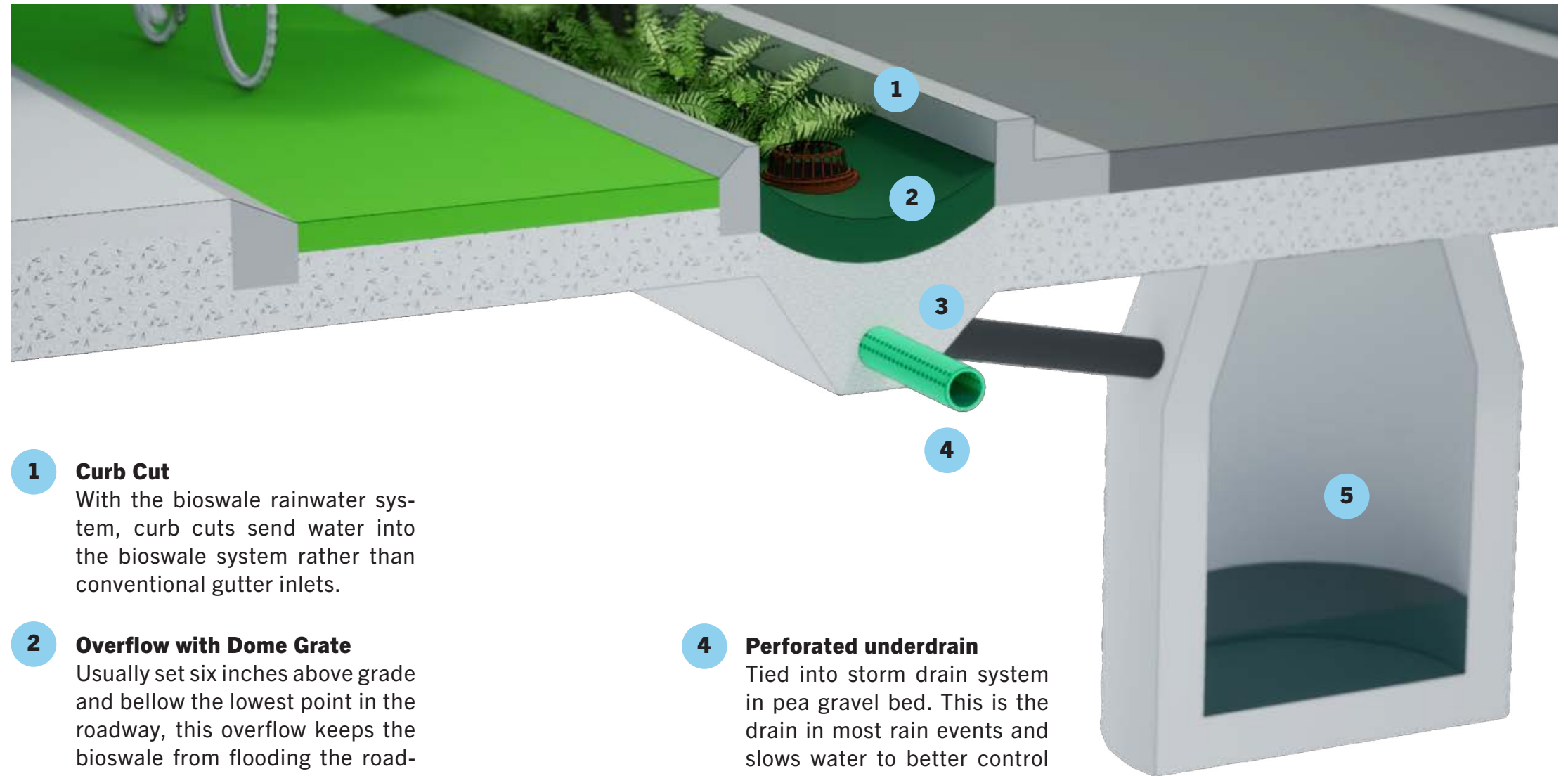

- 1 Curb Cut**
With the bioswale rainwater system, curb cuts send water into the bioswale system rather than conventional gutter inlets.
- 2 Overflow with Dome Grate**
Usually set six inches above grade and below the lowest point in the roadway, this overflow keeps the bioswale from flooding the roadway in heavy rain events after filling the detention provided by the bioswale.
- 3 Engineered Soil Mixture**
Usually consists of a layer of mulch on several feet of soil mix containing half sand, a quarter topsoil and a quarter compost.
- 4 Perforated underdrain**
Tied into storm drain system in pea gravel bed. This is the drain in most rain events and slows water to better control and filter rainwater runoff.
- 5 Underground Storage Tanks**
For increased capacity where needed the option to store more water underground should be considered in cost benefit analysis.

Figure 6L

6.5 Intersection Typologies

One of the most important points in any bicycle path system is where bicyclists intersect with automobiles. The safest and most comfortable opportunities for bicyclists to cross are at signalized intersections. Intersections require reduced speeds to ensure safety for all street users. Turning radii should reflect this increased safety and is covered in this chapter as well. Refuge islands and protective islands also increase visibility and opportunities to remain safe. Reduced speeds give motorists and bicyclists time to react and reduce severe and fatal crashes. Further reduce speeds through traffic signaling (see [Chapter 7](#)) or changes in grades (see [Section 6.5.5](#)).

This chapter provides guidance for geometric layouts for several different scenarios where a Bicycle Lafayette route crosses arterial roads. Featured typological crossings include a one hundred foot crossing of two arterial streets, a sixty-foot right-of-way bicycle route crossing a shared-lane minor road (low traffic count), and a roundabout crossing.

The sixty foot wide intersection typology is categorized into several examples in order to demonstrate multiple scenarios. One diagram demonstrates how two one-way bicycle paths merge into one two-way bicycle path at a signalized intersection while another scenario shows how a two-way path remains the same but crosses to the opposite side of the roadway as it crosses the intersection.

Roundabout features must consider distances between the crossing the bicycle path and entering the roundabout to ensure enough space for vehicles to yield between them. Bicycle path crossings at these points should also be next to the pedestrian crossing and perpendicular to the roadway.

The chapter following this chapter ([Chapter 7](#)) expands upon these intersection typologies by demonstrating several scenarios for traffic signaling timing and various options for safer crossing for pedestrians and bicyclists.



Vancouver, Canada

6.5.1 Bicycle Crossing Features of Intersections

- 1 Pedestrian Crossing Island
- 2 Corner Refuge Island
- 3 Pedestrian Crossing at Bicycle Path
- 4 Motorist Yield Zone
- 5 Bicyclist Turning Box
- 6 No Turn on Red Sign

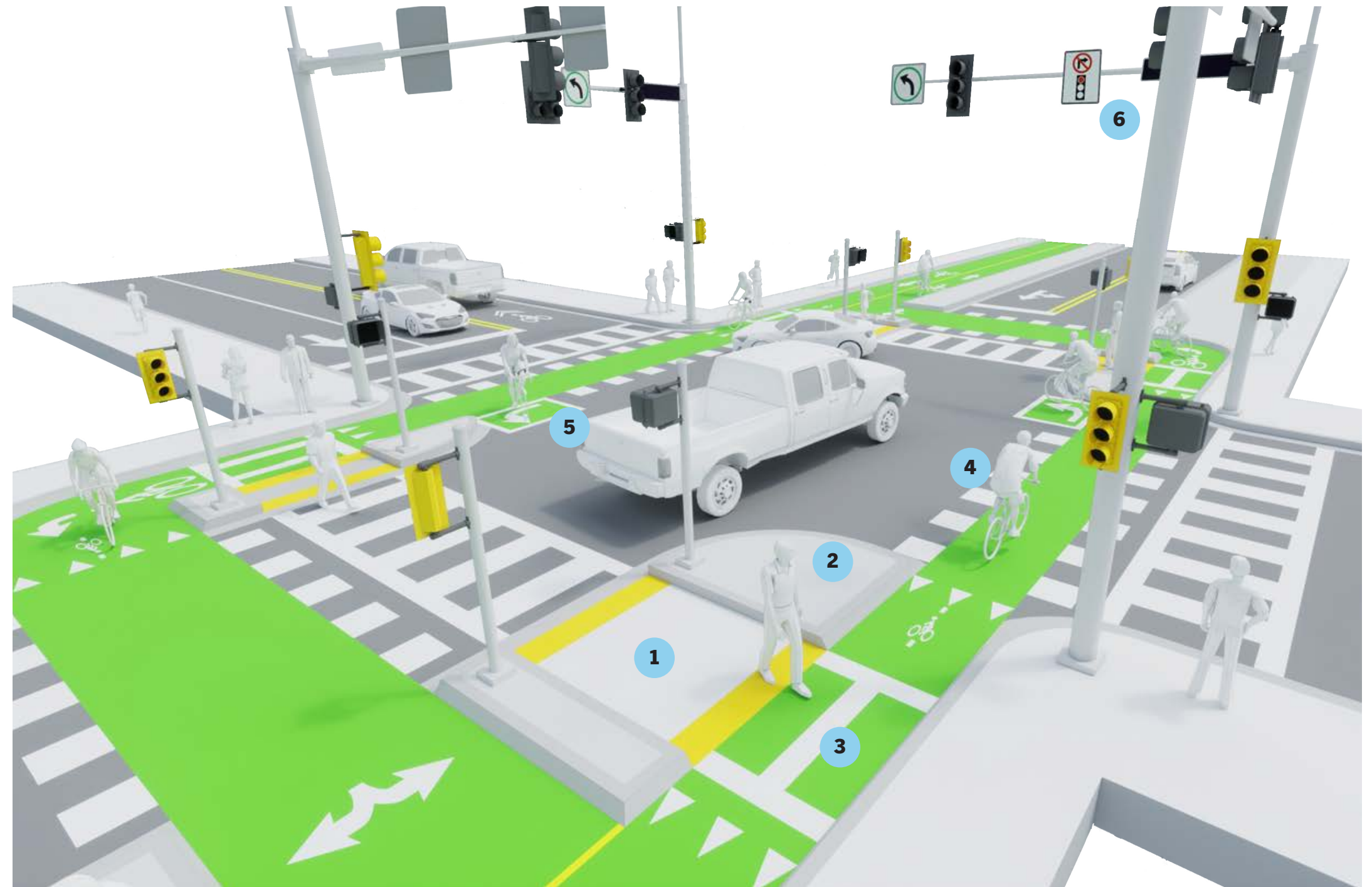

Figure 6M

6.5.2 60' Intersection (A)

This intersection scenario shows how a two-way path remains the same but crosses to the opposite side of the roadway as it crosses the intersection. When crossing a collector or minor street that does not include a planned Bicycle Lafayette route a shared roadway with bicycle turn boxes should be included.

- 1 Reduced Speed Radius**
A fifteen foot turning radius greatly reduces the risk of major injury or fatal accidents with pedestrians and bicyclists (AASHTO, USDOT).
- 2 Bicycle Turn Box**
Should be a minimum of six feet wide in order for a bicycle to fit in the box while waiting for signal to change.
- 3 No Right Turn on Red Sign**
To improve bicyclist and pedestrian safety provide no right turn on red signage. Approved sign from MUTCD can be found in Route Lafayette.
- 4 Directional Striping**
Provide so that bicyclists can quickly recognize directions of travel on paths.
- 5 Zebra Striping**
Provide striping for pedestrians and continue bicyclist color to set priority to protect.

Figure 6N

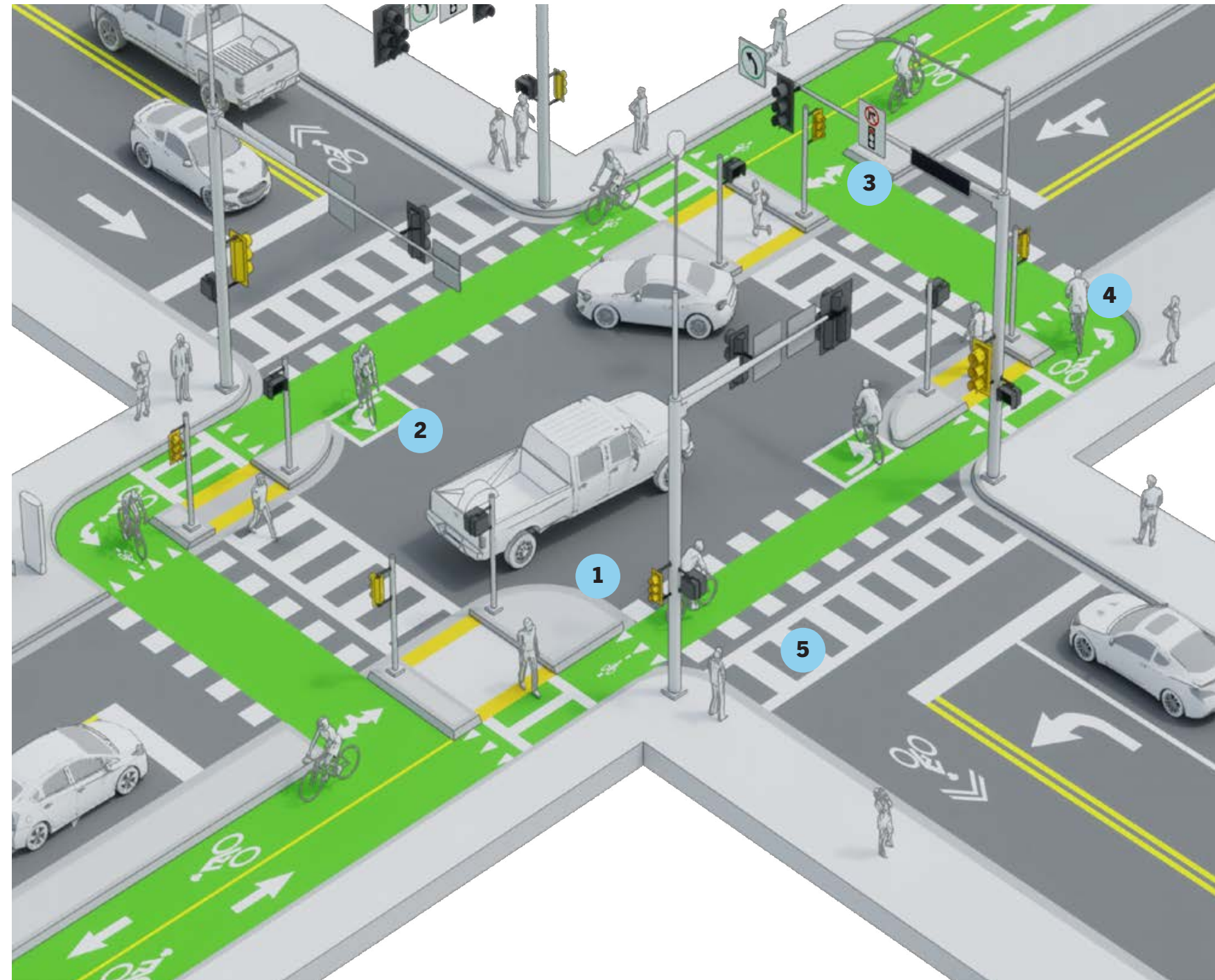

6.5.4

100' Intersection

At the crossing of two arterial streets that include Bicycle Lafayette routes in both right-of-way directions. These arterial intersections pose the greatest safety challenges for bicyclist on the Bicycle Lafayette network and should consider safety of all street users.

- 1 Mountable Truck Apron**
Reduce speed to most vehicle types while allowing tractor trailers to complete turns.
- 2 Recessed Stop Line**
To allow for reduced turning radii at intersection, provide recessed left turn stop line to allow large vehicles such as tractor trailers to complete turns.
- 3 Decisional Wayfinding**
Place route decision signs before intersection to reduce stress. (See [Chapter 9](#))

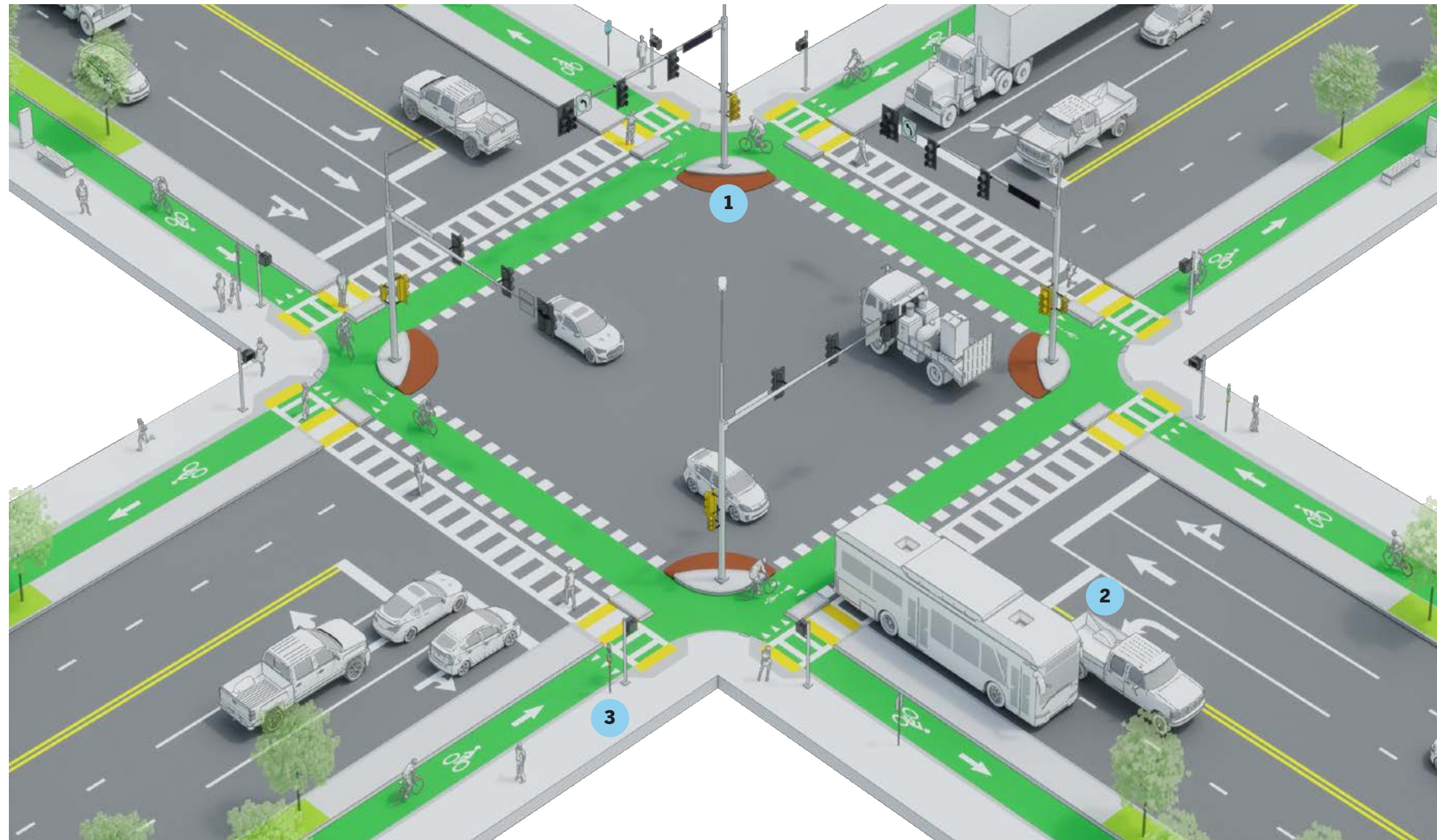

Figure 60

6.5.5 Raised Table Street Crossing + Setbacks for Bicycle Paths

- 1 Motor Vehicle Approach Ramp
- 2 Bicycle Crossing
- 3 Pedestrian Sidewalk
- 4 Bicycle Transition Ramp

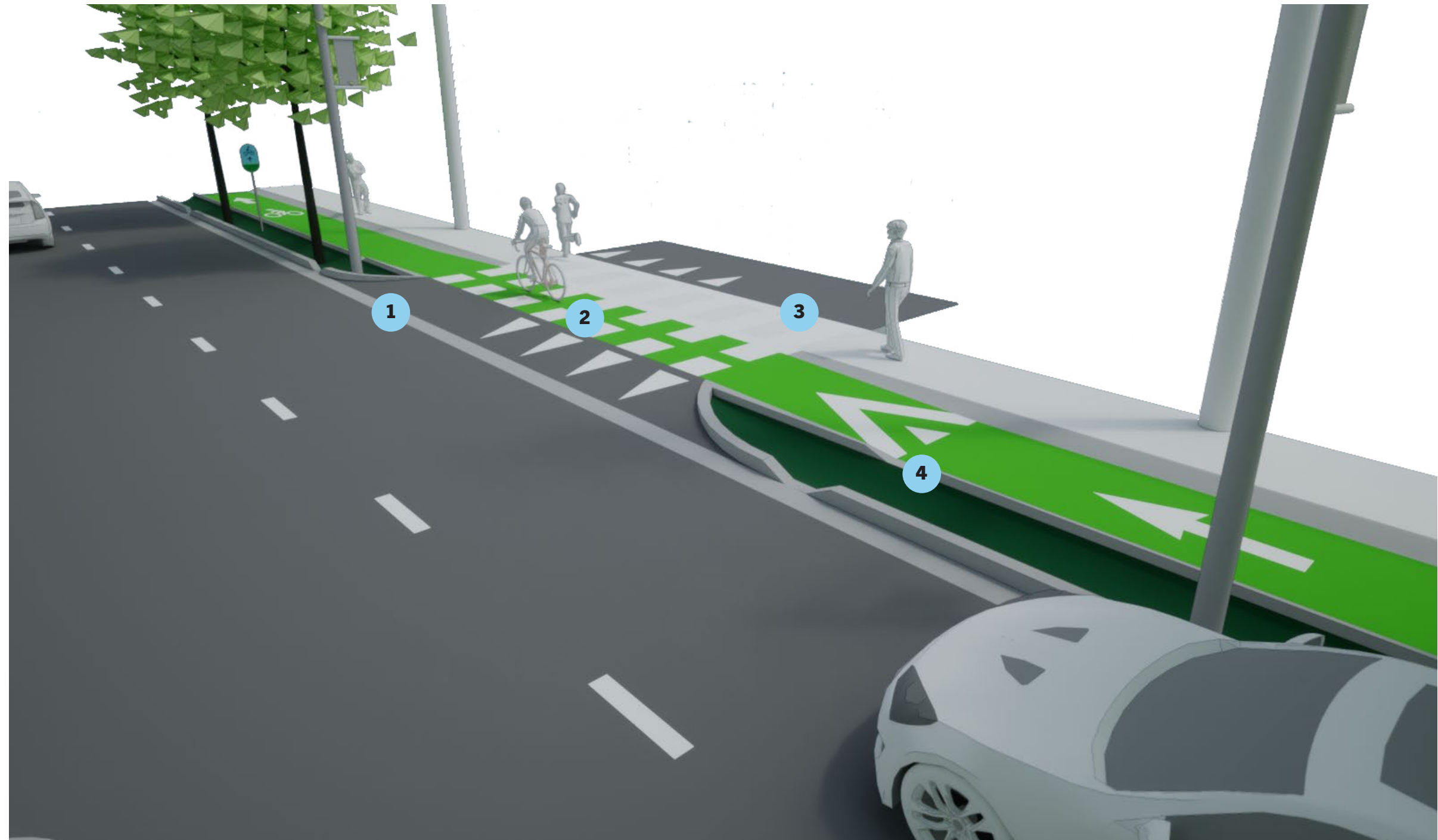

Figure 6P

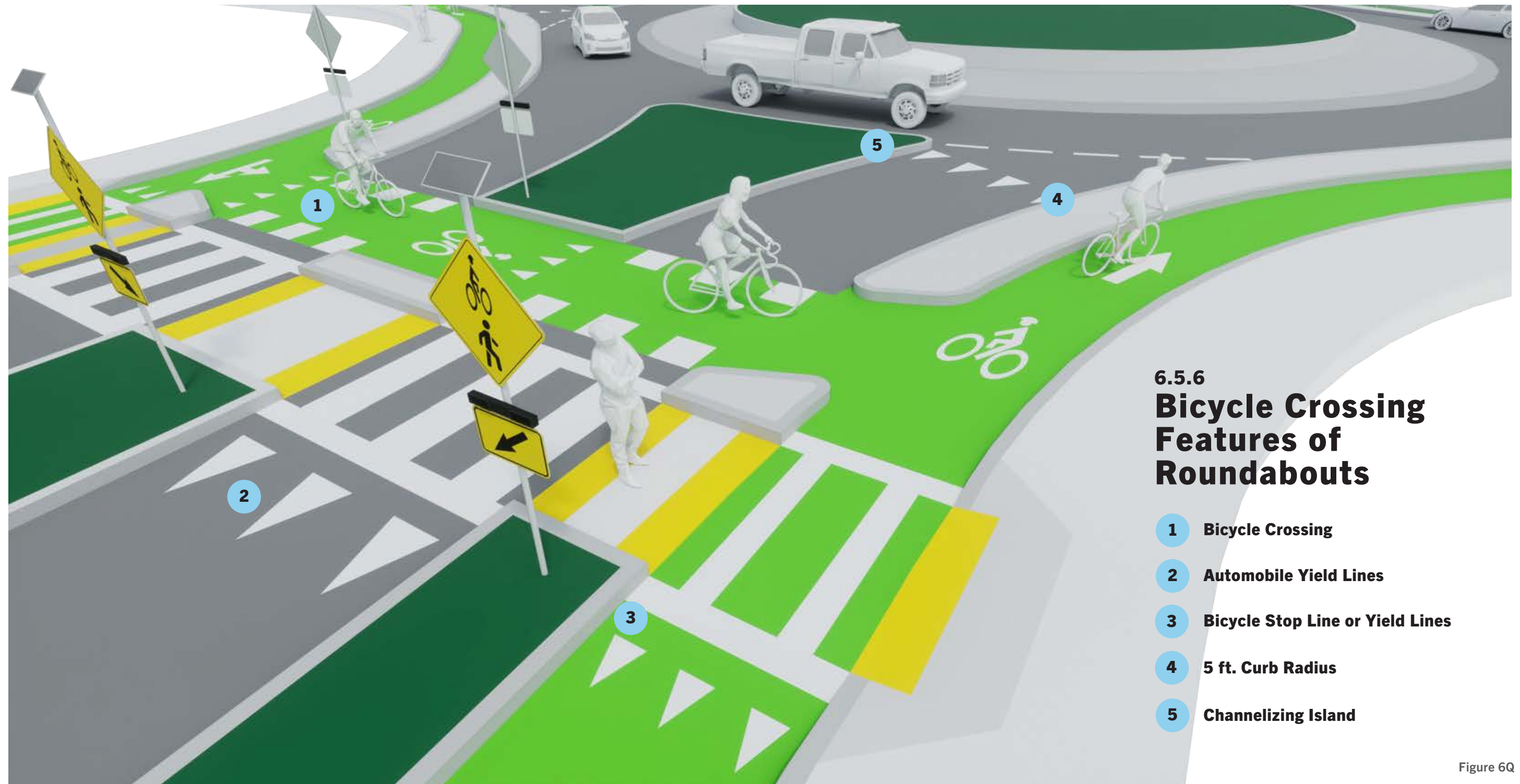
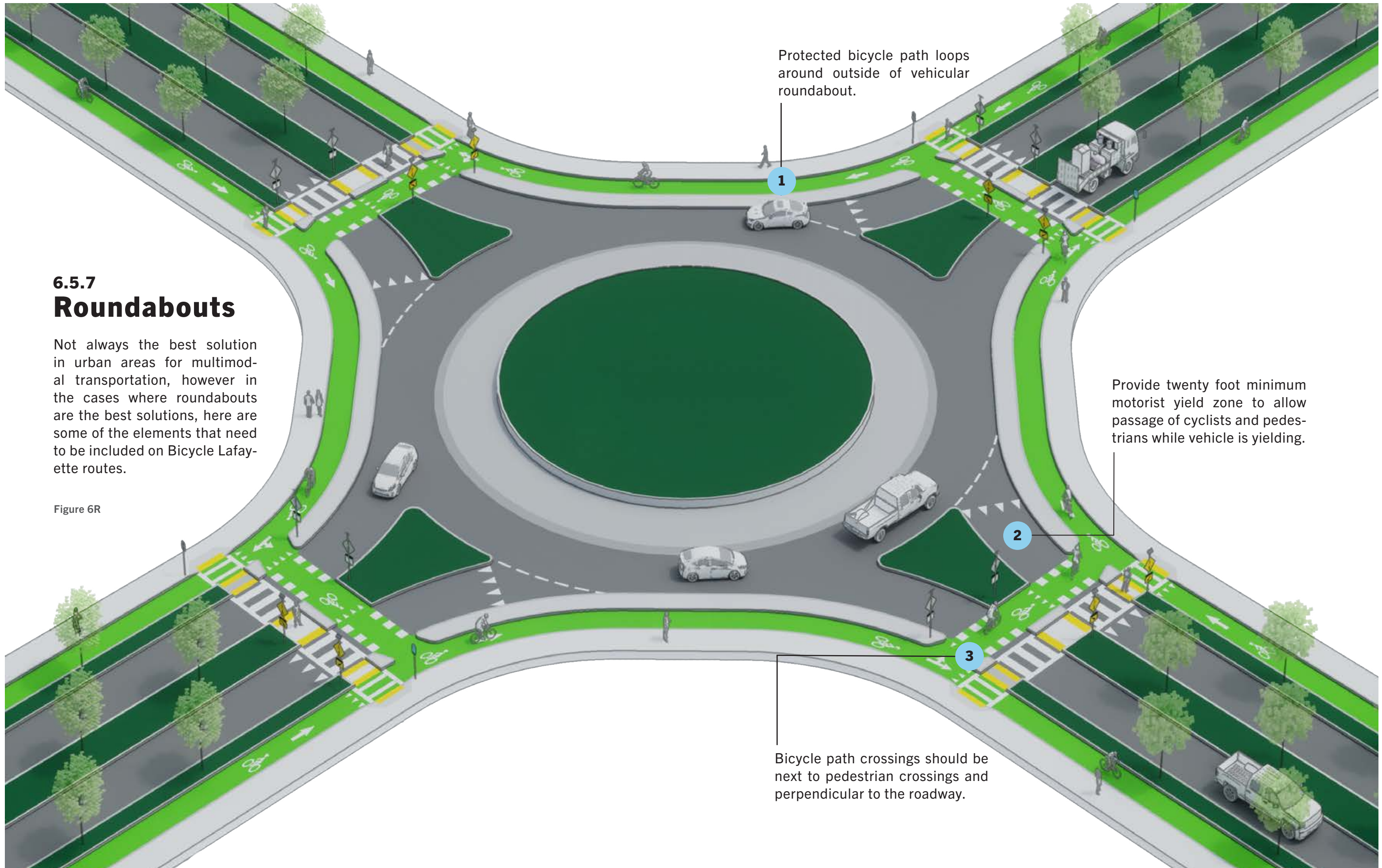

Figure 6Q

6.5.7 Roundabouts

Not always the best solution in urban areas for multimodal transportation, however in the cases where roundabouts are the best solutions, here are some of the elements that need to be included on Bicycle Lafayette routes.

Figure 6R





7

Signaling at Intersections

Because the Bicycle Lafayette system is based on separated bicycle paths the need for separate signaling becomes important in many cases. The Bicycle Lafayette network is designed to increase the amount of bicycle traffic and will likely warrant improved signaling. This chapter explores several options that range from standard phasing to a protected bicycle phase that will become necessary as the volume of bicyclist increases.

7.1 Intersections Signals

7.2 Bike Signal Phasing

7.1 Intersection Signals

- 1 Vehicle Signal
- 2 Bike Signal (Near)
- 3 Bike Signal (Far)
- 4 Pedestrian Signal
- 5 Cyclist Wayfinding Decision Sign

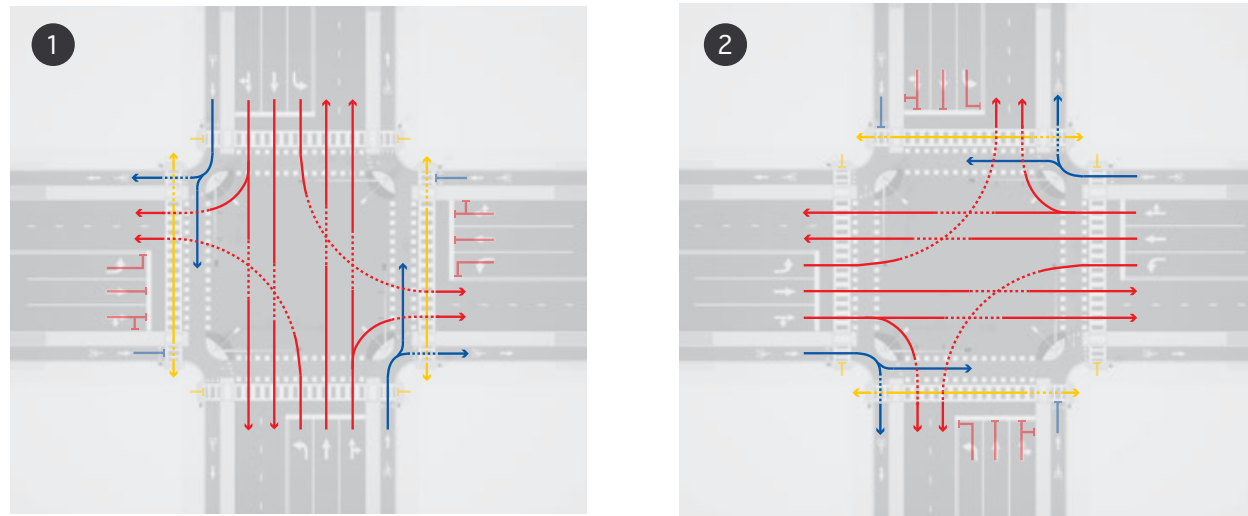

Figure 7A

7.2 Bike Signal Phasing

7.2.1 Concurrent Unprotected Bike Phase

Used only in areas with little bicycle volume and warrant a yield to pedestrians and bicycle sign. This is the least suggested signal phase because the Bicycle Lafayette network is designed to increase the volume of bicyclists in Lafayette.



SIGNALS



MOVEMENTS



7.2.2 Concurrent Unprotected Bike Phase with Leading Interval

An easy solution for initial increased bicycle traffic, this phase is only smarter than the concurrent bike phase because it allows bicyclists and pedestrians a head start into the intersection so that motorists become aware of their presence and are further from their blind spot.

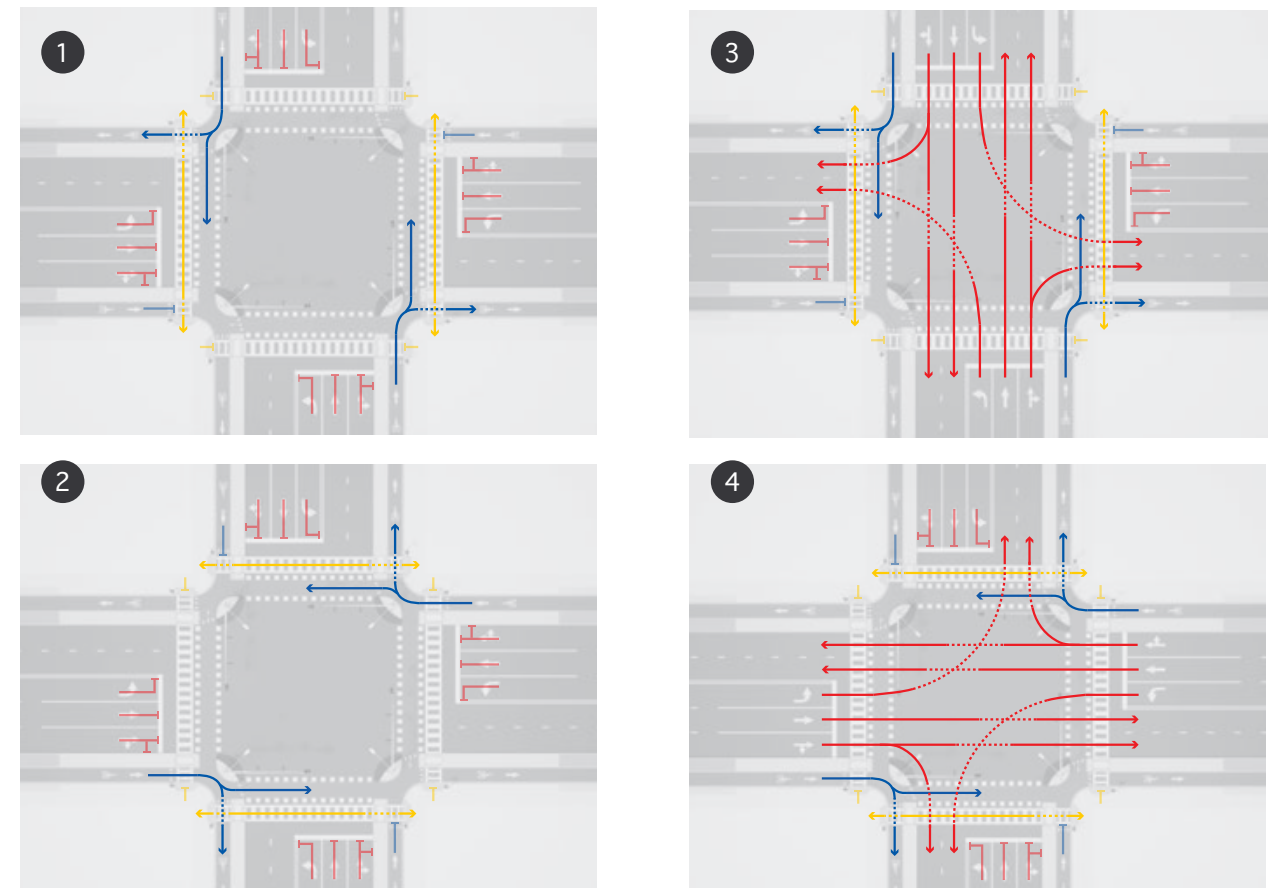

7.2.3 Concurrent Protected Bike Phase

Protected bike phases will likely become necessary as soon as the Véloop is completed and becomes popular. As the Bicycle Lafayette network is built-out the popularity will likely further increase. The concurrent protected phase will likely be the most used for the crossing of two Bicycle Lafayette routes.

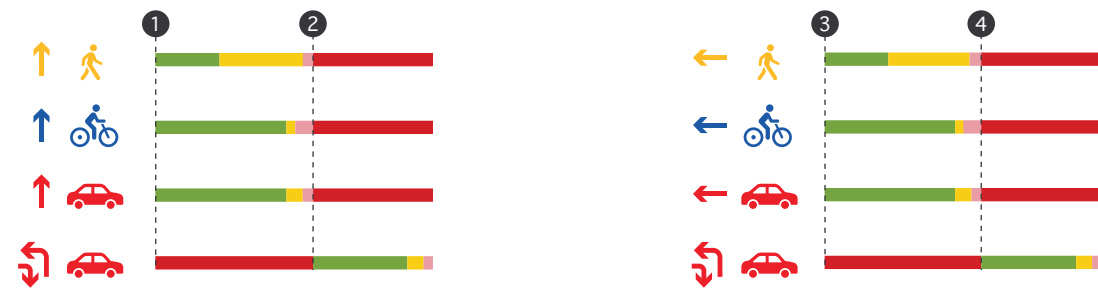
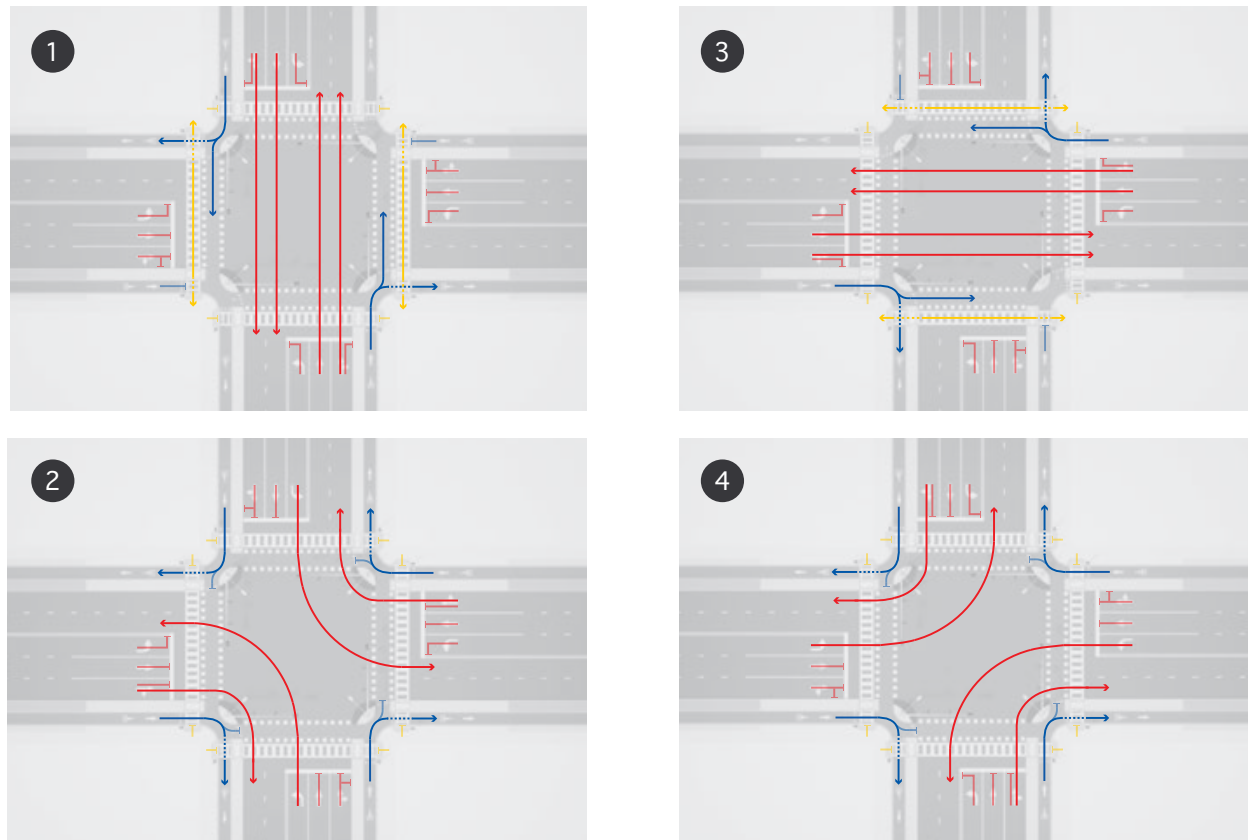

7.2.4 Concurrent Protected Bike Phase for Major and Minor Street Intersection

This phase will become necessary at intersection where Bicycle Lafayette routes are two-way bicycle paths that cross through signals. This will be the case in several locations as the network is build-out.

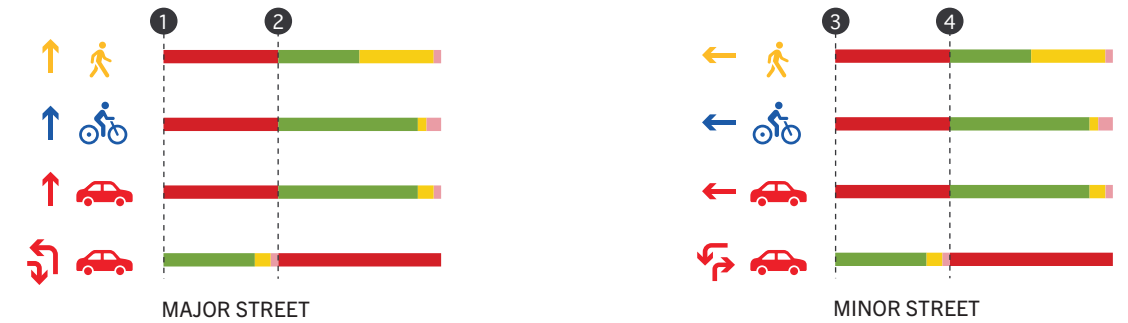
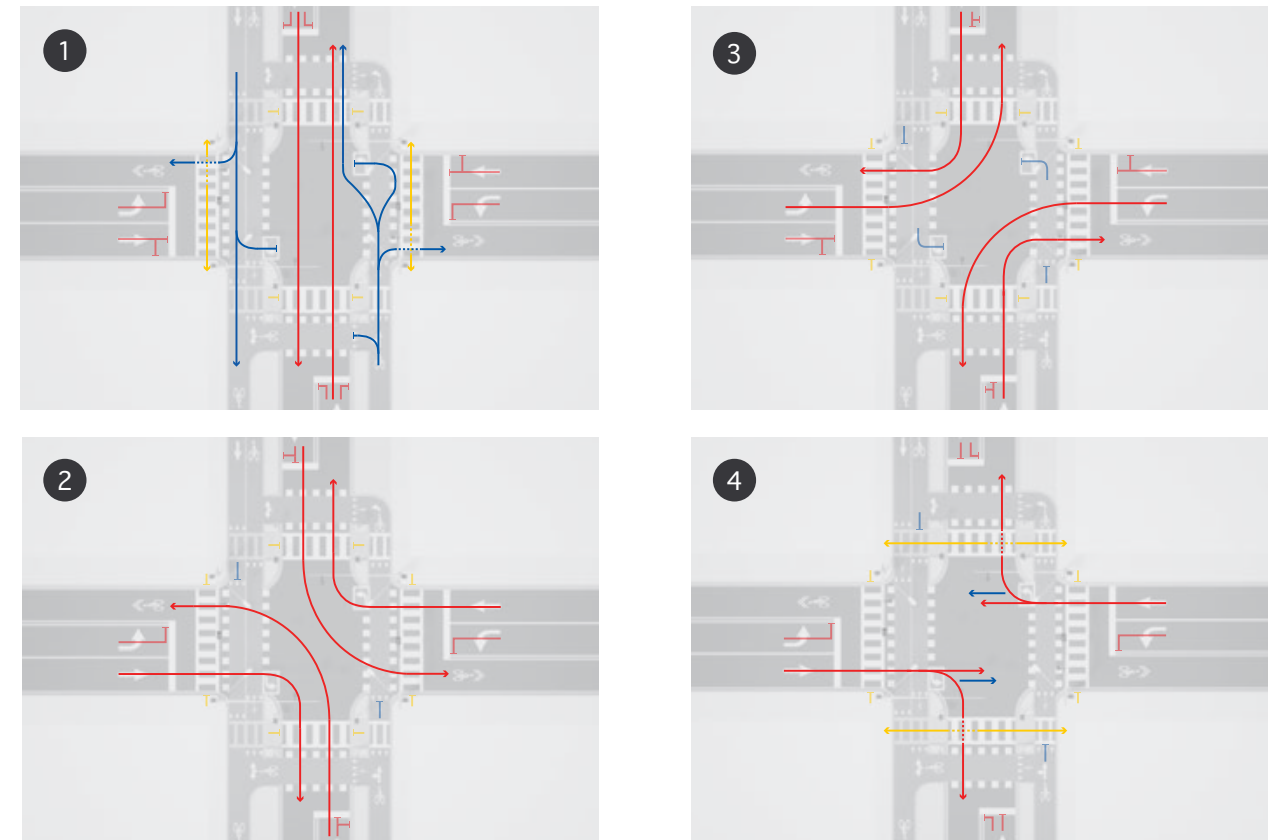



8

Trailheads

A trailhead system layered over the Bicycle Lafayette network helps to ensure that the bicycle system is used for recreation, in addition to commuting. These trailheads can be broken into three types; landmark trailheads, primary trailheads, and secondary trailheads. Each of these types feature a stacking of amenities for bicyclists.

- 8.1 Trailhead Locations
- 8.2 Trailhead Typologies
- 8.3 Trailhead Amenities

8.1 Trailhead Locations Along Véloop

A series of trailheads along the Véloop are located at key intersections, at major destinations and at regular intervals in order to ensure that distances are not too far to allow for ease of use. These trailheads are categorized into three distinct typologies, landmarks trailheads, primary trailheads, and secondary trailheads



Pontiac Point / Lafayette, Louisiana

The landmark trailheads further augment the connection of the Véloop to the Vermilion River at Rotary Point with the connection to the Sterling Grove National Historic District at Pontiac Point. These trailheads are the anchors at both ends while the primary trailheads provide entries to places such as Girard Park, Moncus Park, Heymann Park, Cajun Field, the Cajundome, Downtown at Coulee St. John and Trappey at the Vermilion River. Secondary trailheads are used to fill gaps in order to close distances between trailheads to less than one quarter of a mile, insuring the use of bike and e-bike share programs.

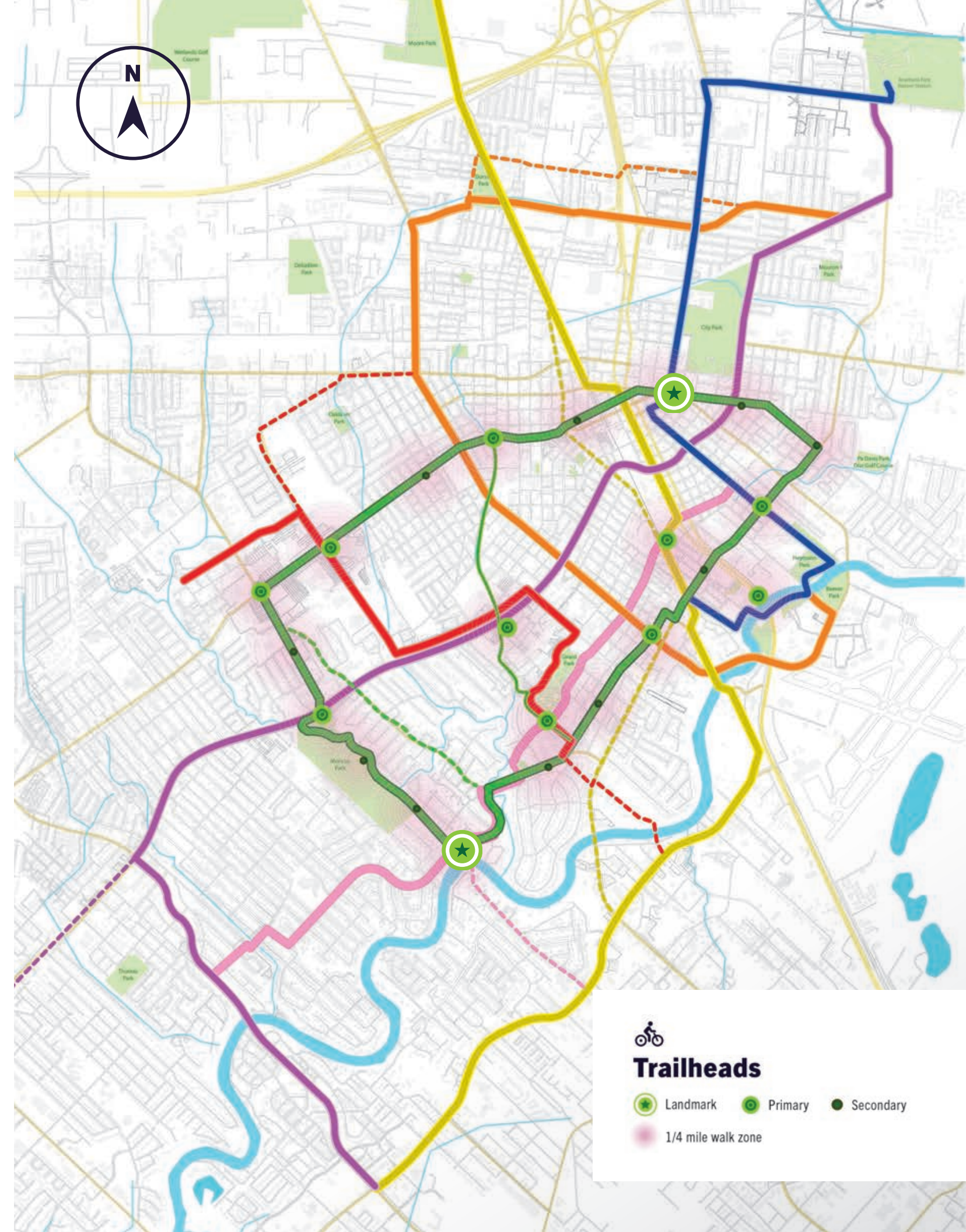

8.2 Trailhead Typologies

Landmark Trailheads
 Featuring several major landmark trailheads helps to ensure that the bicycle system is used for recreational trips. These feature food and beverage opportunities through creating public-private partnerships with restaurateurs. Rotary Point offers great vistas of the Vermilion River on a bluff next to Coulee Mine and can also double as a paddle trailhead. The other end of the Véloop has Pontiac Point Park which can double as a trailhead for historic building tours in the Sterling Grove National Historic district. The idea is that visitors and locals can make a day out of biking around the Véloop and recharge for breakfast, lunch, dinner or a drink at these two landmark trailheads.

Amenities









-  food and beverage
-  repair
-  totems
-  outdoor seating
-  water station
-  e-bike share
-  covered bike parking
-  restroom
-  bike share
-  pump
-  maps



Rotary Point / Lafayette, Louisiana







Primary Trailheads
 These trailheads feature water stations, bike repair areas and wayfinding totems to complete an enjoyable experience for network users.

Amenities

-  outdoor seating
-  bike parking
-  pump
-  repair
-  water station
-  totems
-  e-bike share
-  bike share

Secondary Trailheads
 Secondary trailheads are placed to close gaps to less than a quarter mile distance to trailheads that feature bike share stations. When bike share stations are close, the system is more complete and are more used.

Amenities

-  bike parking
-  pump
-  repair
-  totem
-  e-bike share
-  bike share

8.3

Trailhead Amenities in Street Design

Some of the best places to locate trailheads are where pedestrian crossings are near bus stops and intersections. In order to complete trips, someone may disembark a bus or streetcar and have a need for a bike. Bike share is perfect for this and often can be where the protected islands are created by bioswales either in the roadway median or the separation between the bicycle path and the roadway.

1 Drinking Fountains

Drinking fountains are great ways to help make bicyclists and pedestrians more comfortable and enjoy the Bicycle Lafayette system.

2 Bike Share and Parking

When someone arrives at a destination or begins their trip bike parking or bike share is important to be strategically located.

3 Outdoor Seating

Best if located in shade and near bike parking, provides a place to rest or prepare for a trip.



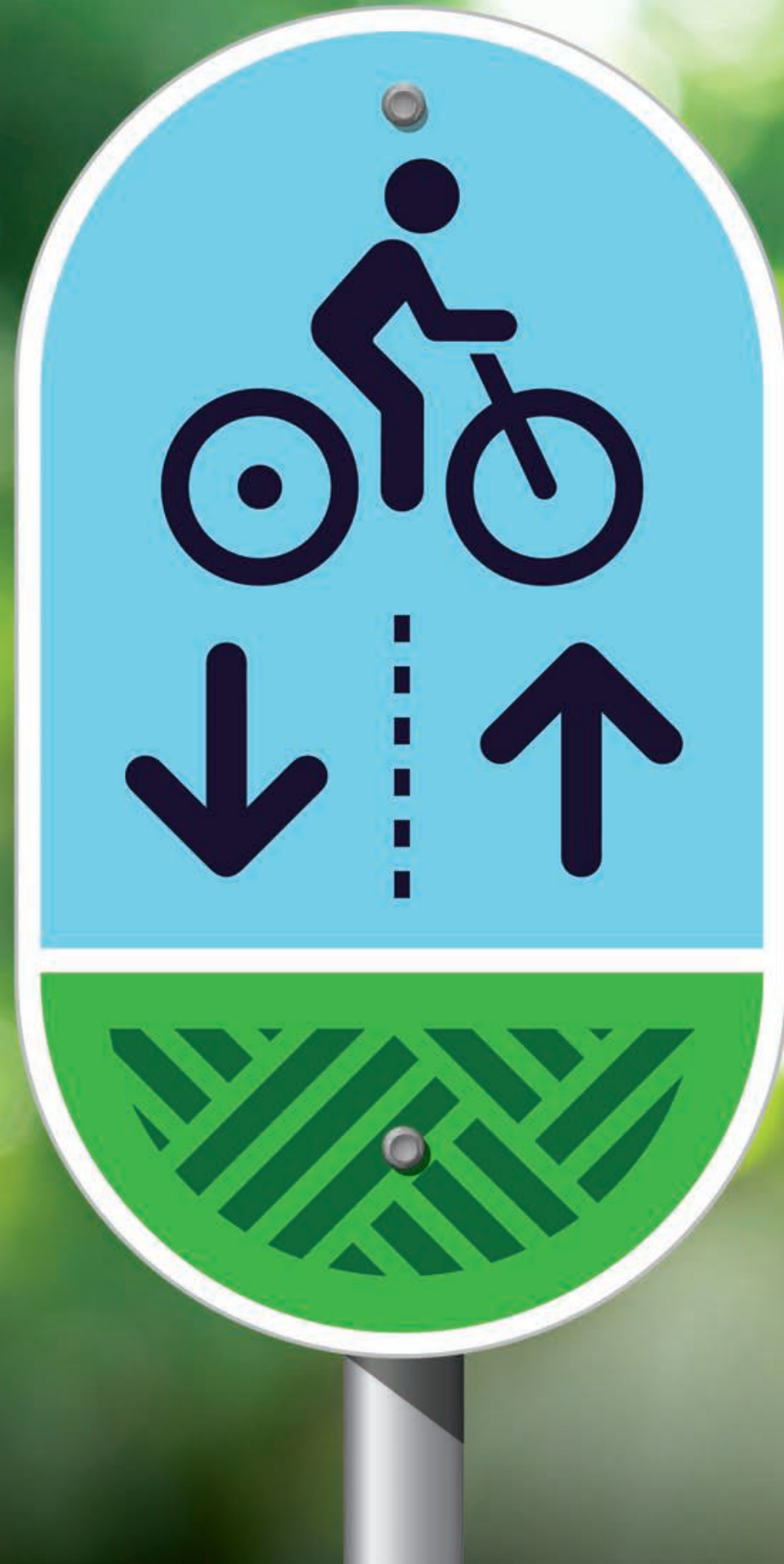

9

Wayfinding Signage

The Bicycle Lafayette wayfinding signage indicates the visual information systems that guide bicyclists through designed bicycle networks and enhance not only their understanding but their experience of a particular space within the entire system (Society for Experiential Graphic Design).

- 9.1 Wayfinding Overview
- 9.2 Colors and Patterns
- 9.3 Arrows and Typography
- 9.4 Sign Family
- 9.5 Trail Maps
- 9.6 Pavement Markings
- 9.7 Design Details

9.1 Wayfinding Overview

Wayfinding signage as well as regulatory signage present visual information to bicyclist as they travel and make decisions along the Bicycle Lafayette network. The role of the signage is to enhance the experience of bicyclists by increasing their understanding of how to properly use designated routes and bicycle paths. As well as providing key navigational information for bicyclists, the consistent use of designated bicycle wayfinding signage reduces stress by providing a sense of reinsurance, safety, and security.

Each one of the bicycle routes within the network proposed in [Chapter 4](#) presents a unique set of challenges for navigating paths, roadways, intersections, and destinations. The following sign designs have been simplified to help reduce cyclist confusion, but some signs may need specific attention because of specific placements or obstacles.

The Bicycle Lafayette wayfinding system has taken Route Lafayette sign designs into consideration (see Section 9.4.4) but does not rely primarily on text based messaging. Instead it relies heavily on symbols, patterns, and colors.



9.2 Colors and Patterns

9.2.1 Route Colors and Patterns

The Bicycle Lafayette system incorporates color coded bicycle routes to create easy to distinguish bicycle paths throughout the city. This color coding (**Figure 9A**) is integral to the functionality and user experience of the Bicycle Lafayette system and should be used consistently.

Figure 9A



Bleu Route Dark
C:100 M:97 Y:37 K:33
Hex #1e2352
RGB: 30, 35, 82

Bleu Route
C:89 M:69 Y:0 K:0
Hex #2e5dab
RGB: 48, 95, 169



Rose Route Dark
C:32 M:96 Y:49 K:15
Hex #9a2b55
RGB: 154, 43, 85

Rose Route
C:0 M:52 Y:9 K:0
Hex #f397b2
RGB: 243, 151, 178



Orange Route Dark
C:19 M:88 Y:100 K:10
Hex #b73f2c
RGB: 183, 63, 44

Orange Route
C:0 M:68 Y:100 K:0
Hex #f17430
RGB: 241, 116, 48



Jaune Route Dark
C:26 M:44 Y:100 K:5
Hex #ba8a37
RGB: 186, 138, 55

Jaune Route
C:13 M:14 Y:100 K:0
Hex #e4ca37
RGB: 228, 202, 55



Violet Route Dark
C:90 M:100 Y:31 K:23
Hex #3b255d
RGB: 59, 37, 93

Violet Route
C:36 M:79 Y:0 K:0
Hex #a65aa1
RGB: 166, 90, 161



Rouge Route Dark
C:29 M:100 Y:76 K:34
Hex #82172e
RGB: 130, 23, 46

Rouge Route
C:0 M:99 Y:100 K:0
Hex #eb262e
RGB: 235, 38, 46

**9.2.2
Vision Impaired Considerations**

The Bicycle Lafayette system relies heavily on color coding bike routes to create easy to distinguish bike paths throughout the city. However, some users may suffer from affected vision. The two most common forms of affected color vision (**Figure 9B**) are found in red/green color-blindness: deuteranopia (reduced sensitivity to red light) and protanopia (reduced sensitivity to green light). In these cases, color discernment is more difficult and the use of patterns should be employed to make bicycle routes more equitable, discernible and easier to navigate. The following colors and patterns will not universally work for every single person, but have been chosen carefully to make them easy to understand and provide a universal language for a variety of people with different levels of literacy, language background, and color vision.

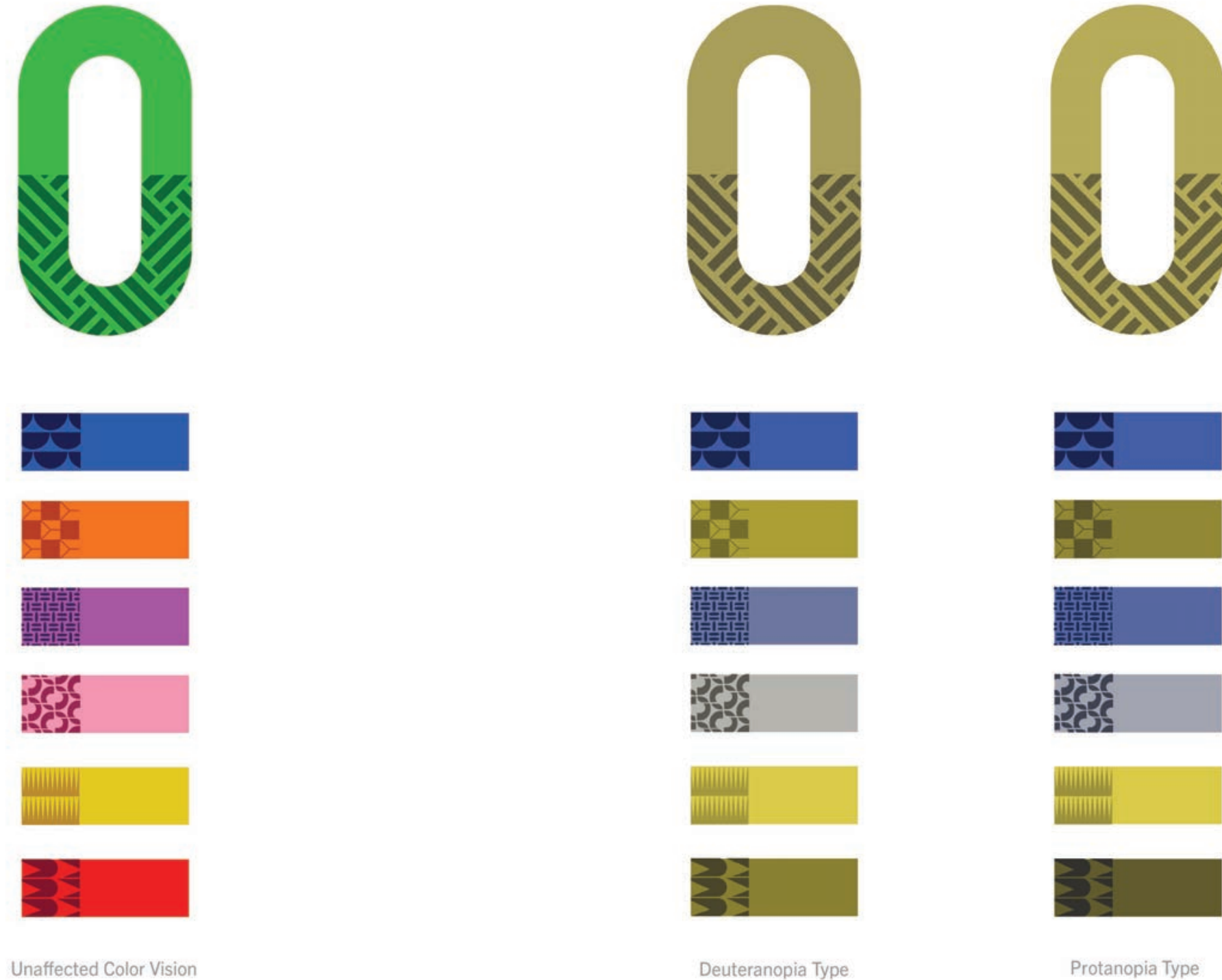

Figure 9B

9.3 Arrows and Typography

9.3.2 Arrows

On decision signs, the cyclist arrow is always presented in navy on white. (Figure 9C) Whether included on one sign or a sign stack, the arrow hierarchy must always follow this format:

1. Forward & Up
2. Right
3. Left

When used for bicycle lane directional signage, arrow is presented in navy on the Bicycle and Accent Blue (Figure 9E).



Figure 9C

9.3.1 Bicycle Lafayette Typography

(Figure 9D) In some instances, the Bicycle Lafayette wayfinding signage utilizes the font Trade Gothic Next LT Pro Bold. Regular variants of the font should not be used and the condensed bold version should be avoided when possible.

The foundation for the Bicycle Lafayette colors is consistent with the Route Lafayette color system using distinguished colors for background, arrow, and typography. It is imperative to keep these colors designated to their corresponding aspects in order to distinguish them from each other and create consistency throughout the city (Figure 9E).

Trade Gothic Next Bold

ABCDEFGHIJKLMNOPQRSTUVWXYZ
 abcdefghijklmnopqrstuvwxyz
 123456789

Rue Lafayette St



Figure 9D



Background
 C:90 M:90 Y:47 K:62
 Hex #191231
 RGB: 25,18,49



Bicycle and Accent
 C:49 M:0 Y:7 K:0
 Hex #76CFE7
 RGB: 118,207,231



Asset/ Destination Text
 C:0 M:0 Y:0 K:0
 Hex #FFFFFF
 RGB: 255,255,255

Figure 9E

9.4 Signage Family

In the Bicycle Lafayette system, there are three general types of wayfinding signs:

1. Lane Direction Signs
2. Confirmation Signs
3. Decision Signs

Sometimes it is necessary to keep these type of signs separate while other times it is more viable to combine them.

9.4.1 Bicycle Lane Direction Signs

The purpose of bicycle lane direction signs is to indicate to bicyclists the direction of cycling flow. Signs or sign stacks should include bicyclist icon and one way or two way arrow depending on the specific part of a route (**Figure 9F**). Signs should be placed alongside route near trailheads or other entry points. Lane direction signs should be accompanied by pavement markings that enforce the direction of cycling flow.

Bicycle lane direction signs correspond with the visual language set forth by the design guidelines of Route Lafayette. These signs can be used on the Bicycle Lafayette network paths outlined in this master plan but can also be used throughout the city on shared biked paths and other bike trails to indicate the direction of cycling flow.

In some instances, bicycle lane direction signs can be custom paired with route color confirmation signs to provide a cleaner visual look (see Section 9.4.2).

Figure 9F

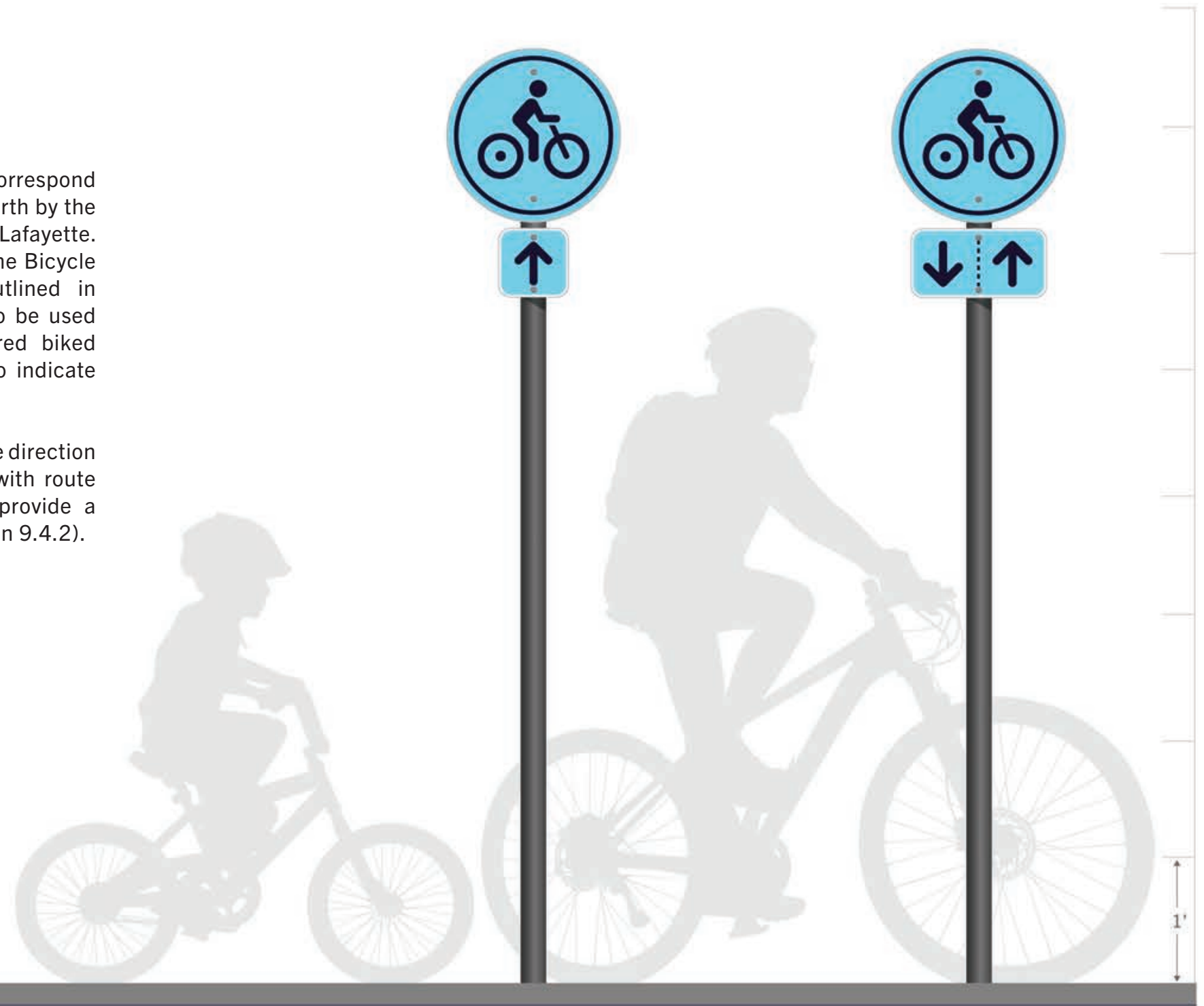

**9.4.2
Bicycle Lane Direction
Signs with Colored Route
Confirmation**

(Figure 9G) For a cleaner visual look, a custom pill-shaped sign is recommended to demonstrate lane direction and colored route confirmations.

Signs should include bicyclist icon plus one way or two way arrows depending on the specific part of a route. The bottom part of the sign should include route color and corresponding pattern (Figure 9H). It is important not to include destinations, destination arrows, distances or times on these particular signs.

Dimensions for signs and the elements contained within them can be found in Section 9.7.



Figure 9G

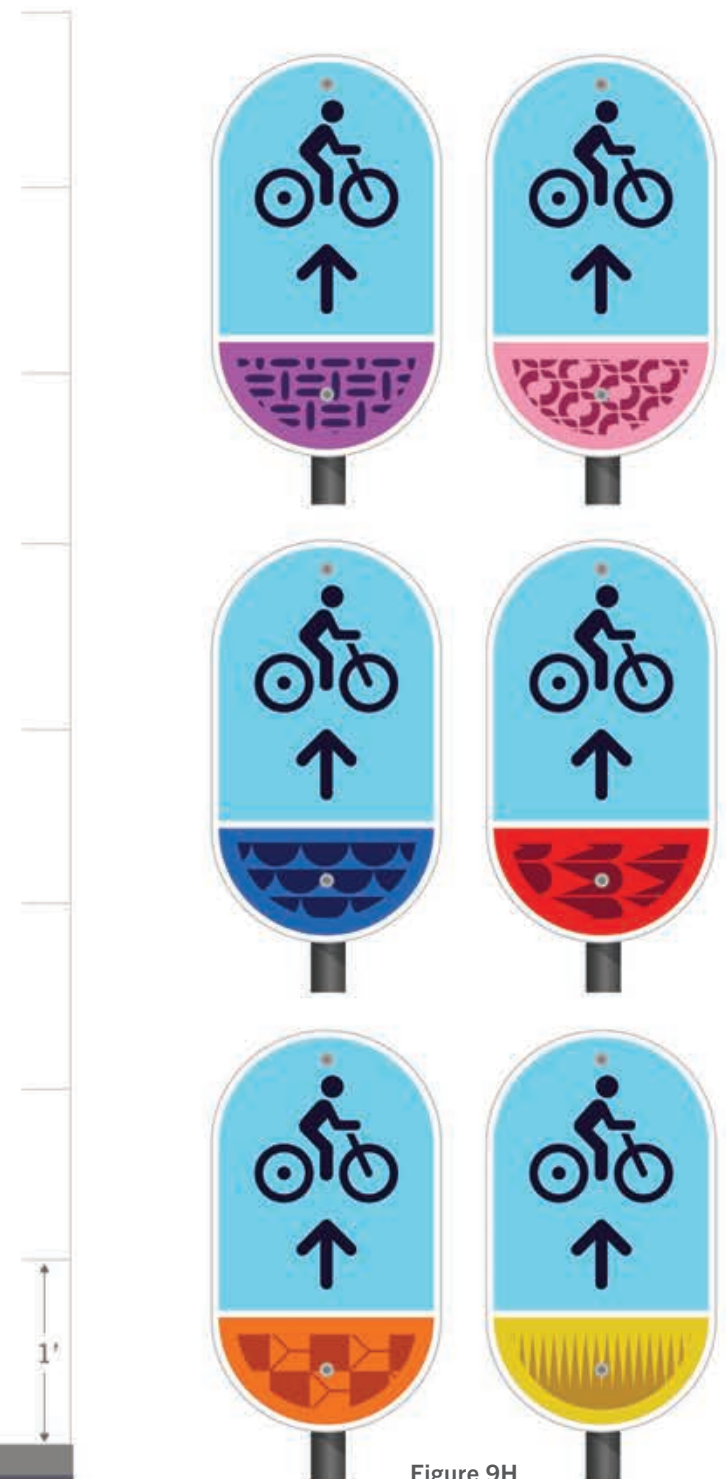

Figure 9H

9.4.3 Colored Route Confirmation Signs

Colored route confirmation signs are used to indicate to cyclists that they are on a designated bike route. Signs should include color and corresponding pattern. In some specific instances the name of the lines may need to be included but do not include arrows, destinations, distances and times. Bicycle Lafayette confirmation signs have been designed to be consolidated with other signs when applicable (**Figure 9F**, **Figure 9G**).

Some form of confirmation should be placed every $\frac{1}{4}$ to $\frac{1}{2}$ mile on off-street facilities and every 2 to 3 blocks along bicycle facilities, unless another type of sign is used, e.g., within 150 ft of a turn or decision sign (NACTO). Colored route pavement markings can also act as confirmation that a bicyclist is on a preferred route.

Note: It is important to consider surroundings when placing confirmation signs. Confirmation signs may need to be scaled down and less distracting as they are placed near neighborhoods or along recreational trails (**Figure 9I**) while scaled up if competing with other signs or placed within a more urban environment.



Figure 9I

**9.4.4
Colored Route Decision Signs**

Colored route decision signs mark the junction of two or more bicycle routes in the Bicycle Lafayette network. It is recommended to include arrows, route color, and route pattern. Decision signs should be placed near-side of intersections in advance of a junction with another bicycle route. Colored Route Decision Signs should also be placed soon after turns or other decided movements to confirm current route or newly picked route(s).

Colored route decision signs should consider location when deciding on the use of low profile or smaller neighborhood type signs (Figure 9J) or more urban/larger intersection signs (Figure 9K).



9.4.5 Route Lafayette Decision Signs

Route Lafayette decision signs are signs that include the direction of key destinations. It is recommended to include arrows, destinations, and travel times. Decision signs should be placed near-side of intersections in advance of a junction with another bicycle route or along a route to indicate a nearby destination. Decision sign designs (Figure 9L) have been set by the Cycling Wayfinding section of the Route Lafayette Graphic Design Guidelines and Standards manual.

Colored route confirmation signs or bands may be added or stacked to Route Lafayette decision signs to communicate which route a cyclist is currently on and reduce the number of colored route confirmation signs along a particular route.

It is important to consider that each decision sign does not inherently need a colored route sign or band. This is evident in cases where decision signs are placed off of designated route paths.



Figure 9L

9.5 Trail Maps

9.5.1 Trail Map Purpose

Bicycle Lafayette trail maps (**Figure 9M**) help cyclists orient themselves within the entire Bicycle Lafayette system by looking at one image.

Bicycle trail map signs may be periodically placed along bike routes to provide additional wayfinding benefits to users (NACTO).

Trail maps should include:

- A simplified illustration of the entire system
- Colored routes and their corresponding patterns
- Trailhead markers
- The Vermilion River
- Recognizable landmarks
- A prominent north arrow
- Vous / You indicator
- Legend

Figure 9M

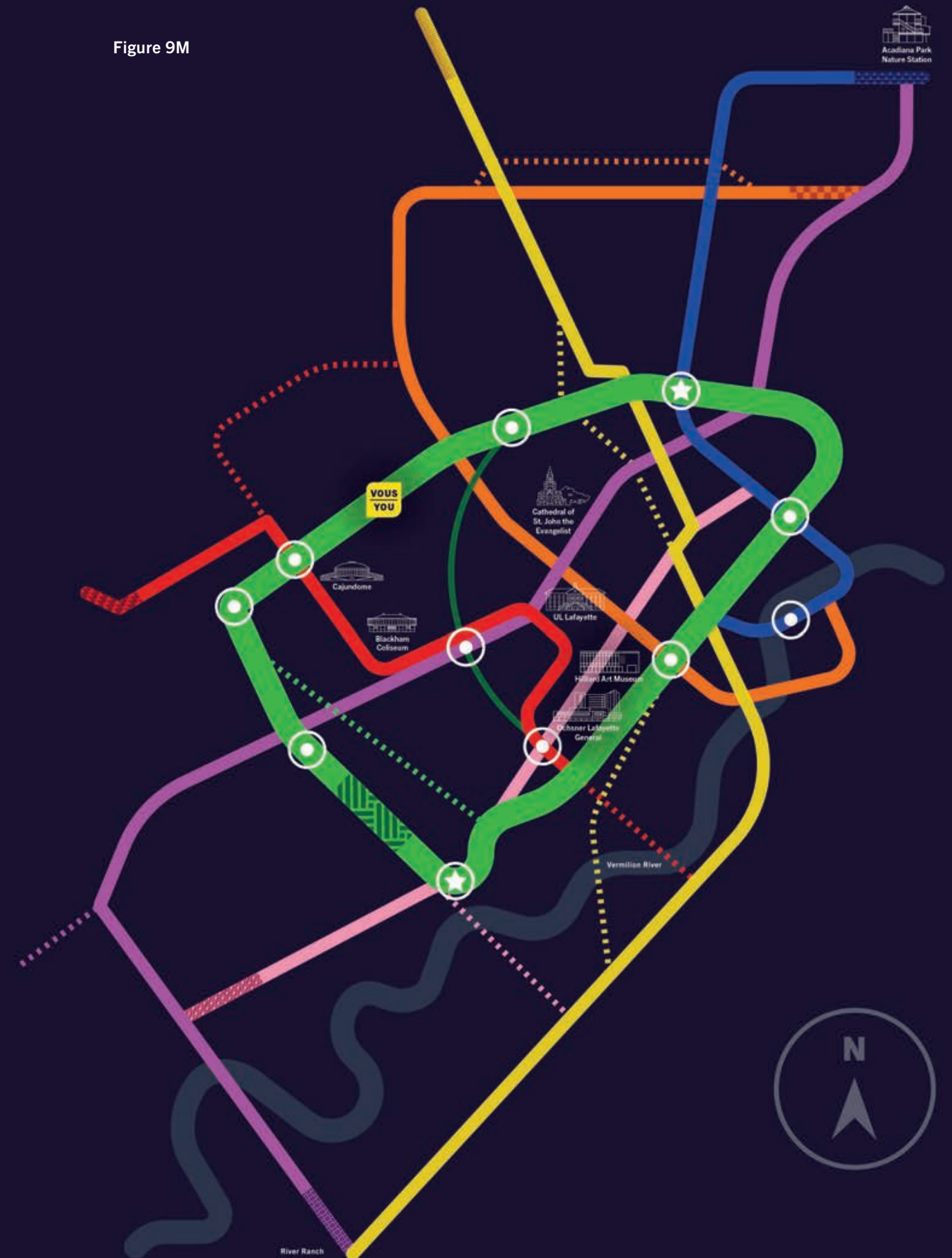

9.5.2 Totems

Freestanding totems orient cyclists to their particular location along a route, offer regulatory information, and provide a larger overview of route connections and their proximity to different assets and destinations within the Bicycle Lafayette system.

The Bicycle Lafayette totem design (Figure 9N) complements the Route Lafayette pedestrian totems and presents information in a similar fashion in order to keep consistency throughout the city.

9.5.3 Mounted Signs

Mounted signs (Figure 9O) offer the same information as totems but may vary in size and shape. These signs will need to be addressed and designed for specific locations as needed.



Figure 9N

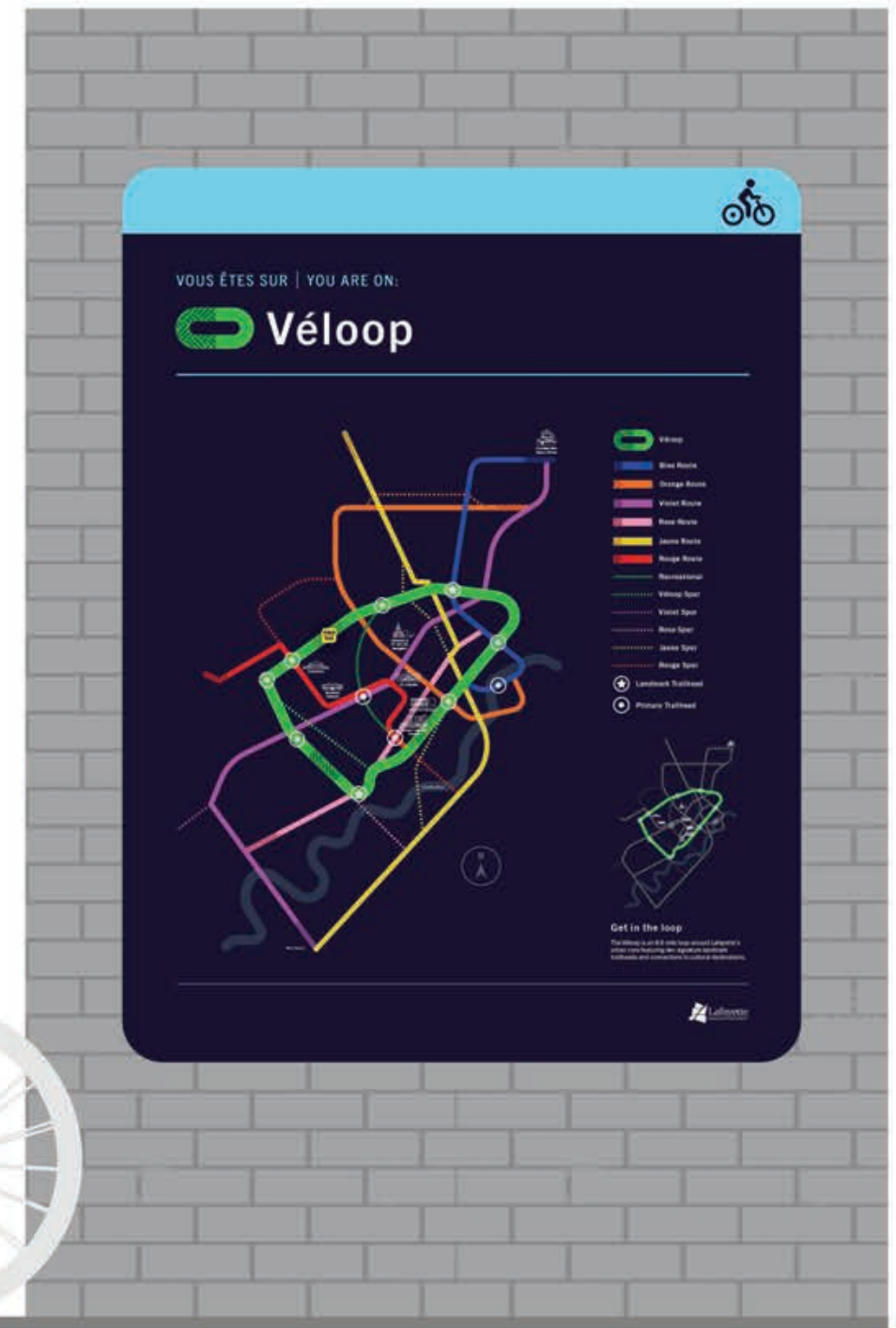

Figure 9O

9.6 Pavement Markings

9.6.1 Bicycle Lane Pavement Markings

Pavement markings are a key feature of the Bicycle Lafayette bike paths. Designating a bicycle lane with street markings helps reinforce information to cyclists by distinguishing bike paths from pedestrian walking paths, informing user of possible

shared lanes, and demonstrating which direction bicycle flow is going. Examples presented below follow sizing determined by MUTCD Figure 9C-3 but other sizing may need to be considered depending on the nature of final path designs.

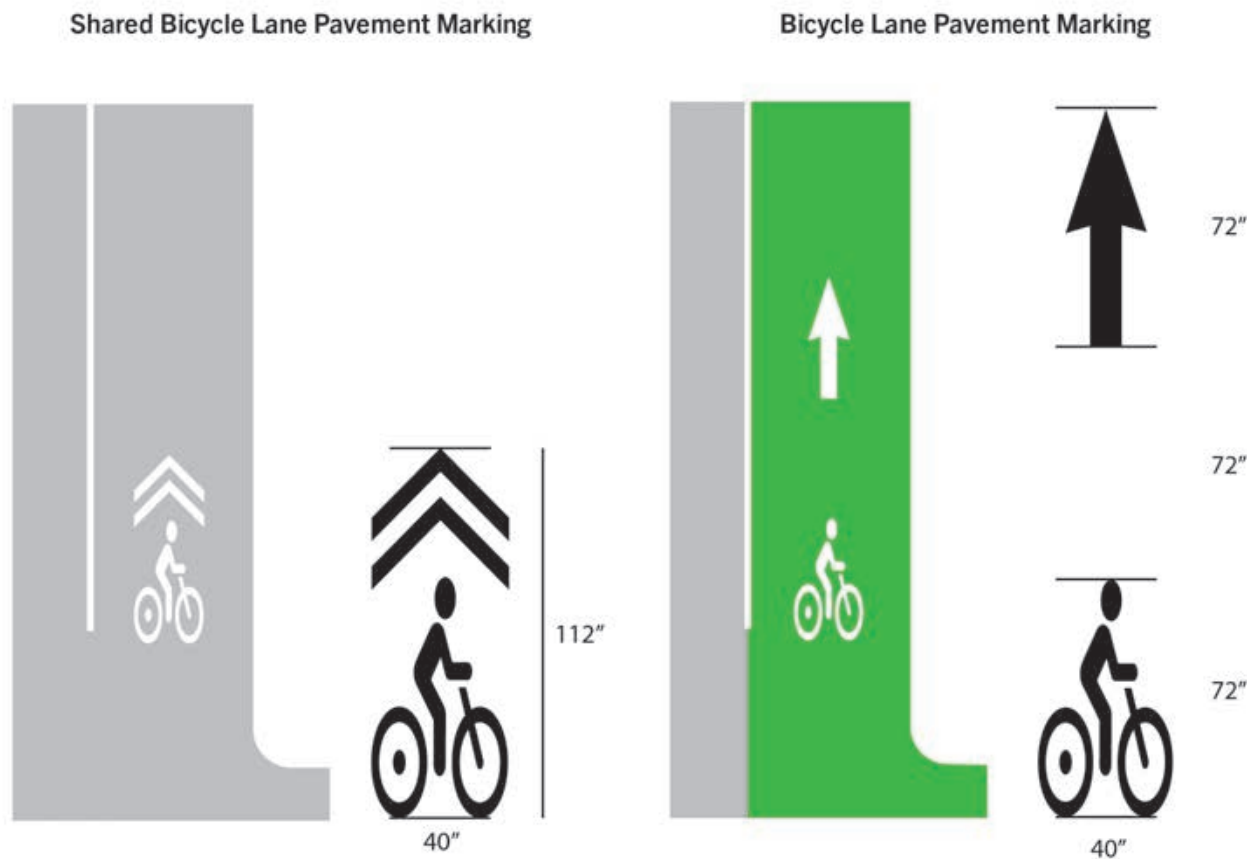

9.6.2 Bicycle Intersection Pavement Markings

Pavement markings are especially important at intersections where cyclists need to know what kind of movements are allowed. These movement arrows should be in white on MUTCD approved green and placed at appropriate locations on paths and in turn boxes of intersections. For arrow proportions, elongated versions, and regulations refer to MUTCD Figure 3B-24.

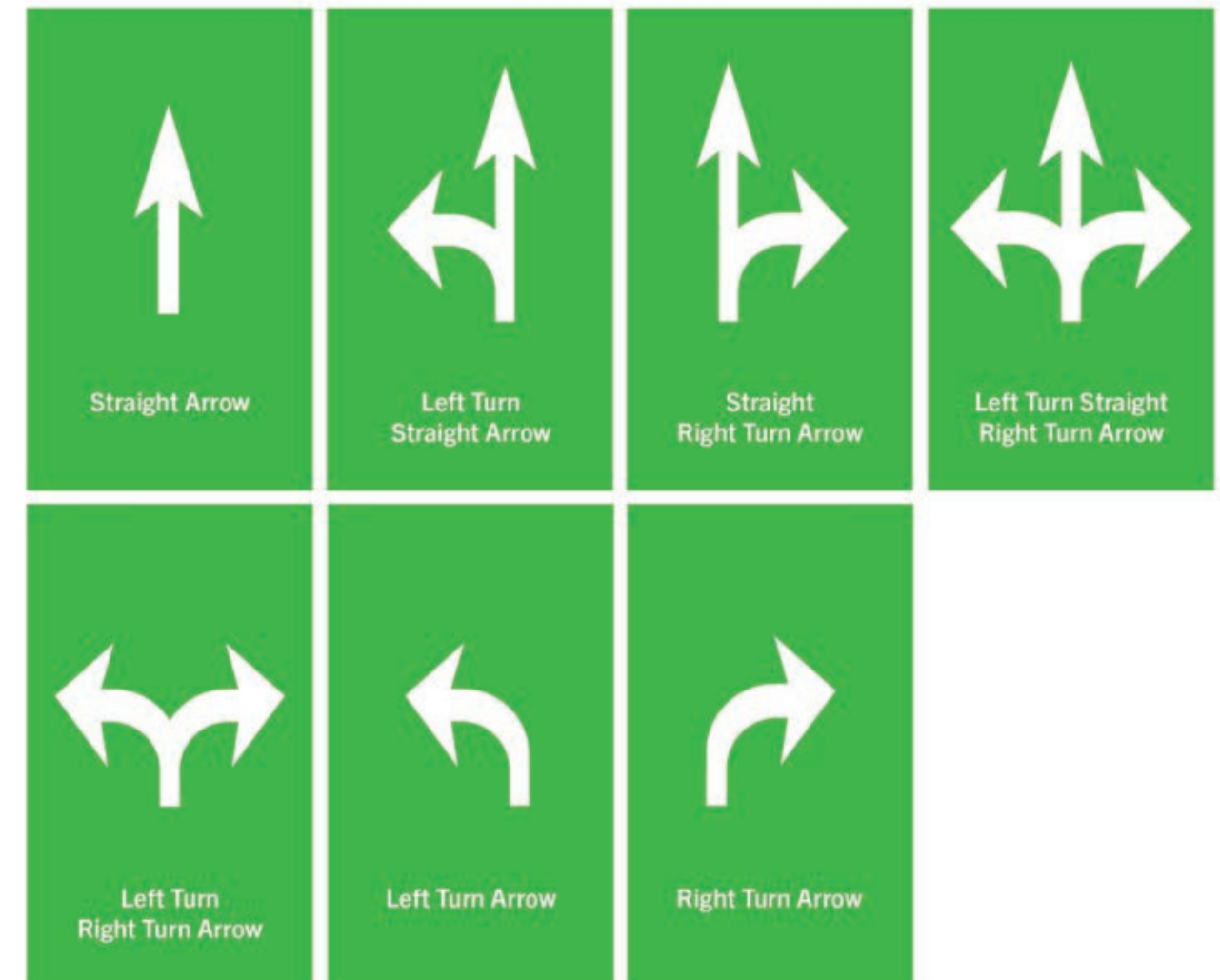

9.7 Design Details

Keeping wayfinding signs consistent is integral to the functionality and user experience of the Bicycle Lafayette system.

When deciding on which signs to use, it is important to consider multiple issues. The size of the wayfinding signs should be appropriate to the sign's surroundings and should not feel out of place. Also consider if the sign is being placed at a particular location to inform cyclist of what route they are currently on, which direction an asset/destination might be, or

is the sign providing safety or other regulatory information to cyclists, pedestrians or motorists.

Note: The following design details are presented at specific sizes. The overall sign size may need to be adjusted for a variety of reasons, but the elements contained within the designs should maintain the same proportion as they are scaled up or down.

Two Way Bicycle Directional Sign

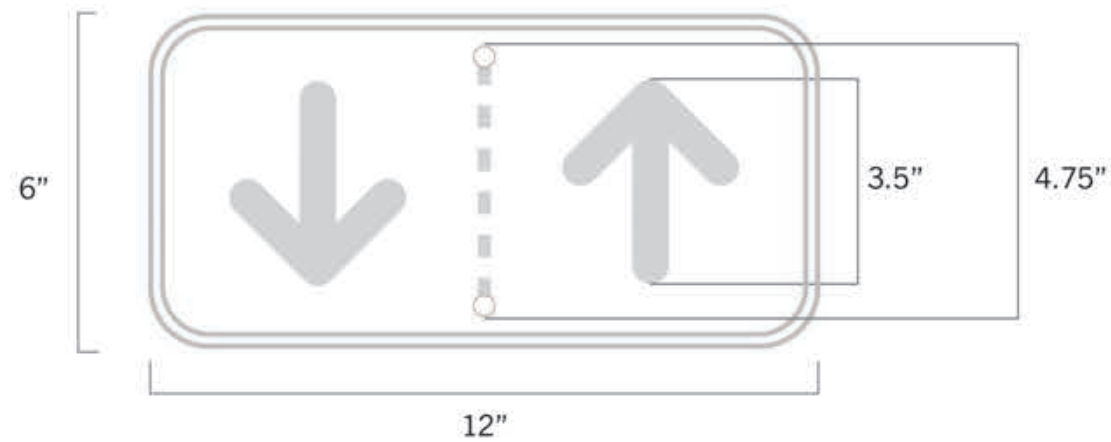

Bicycle Lane Sign & One Way Bicycle Directional Sign (Stacked)

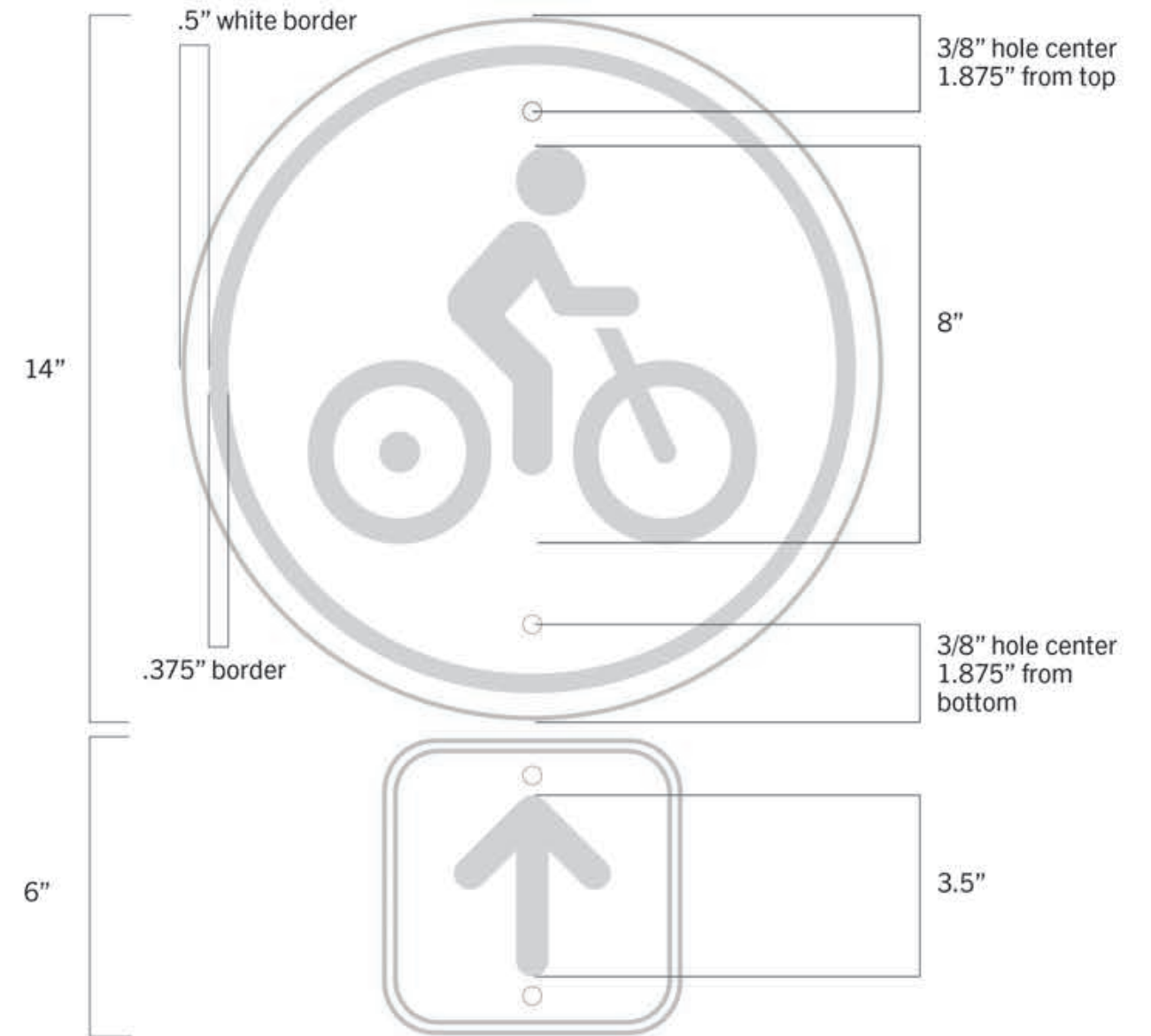

One Way Bicycle Directional Sign with Color Route Confirmation

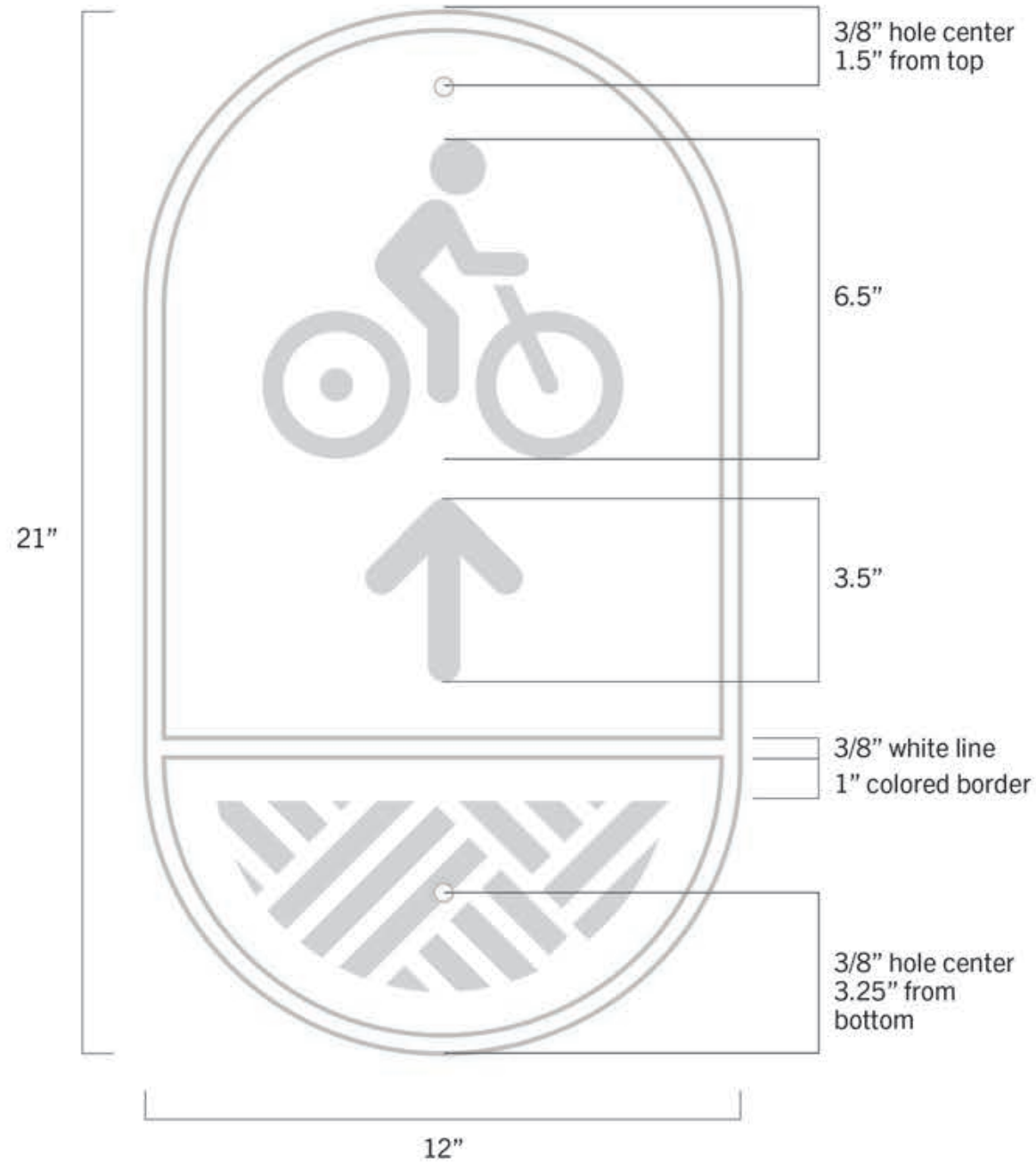

Two Way Bicycle Directional Sign with Color Route Confirmation

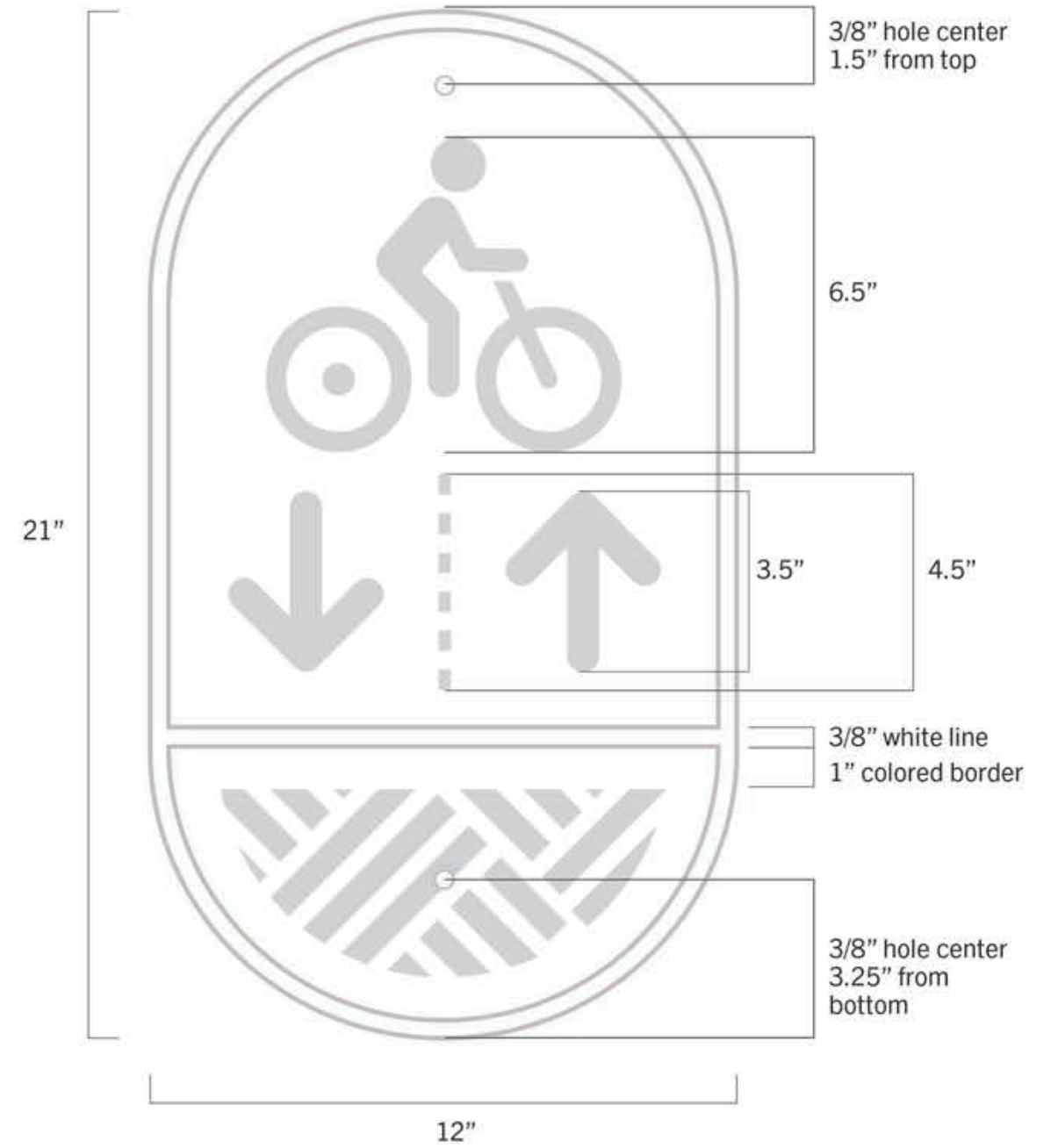

**Cyclist Route Decision/Direction Sign
(Neighborhood Consideration)**

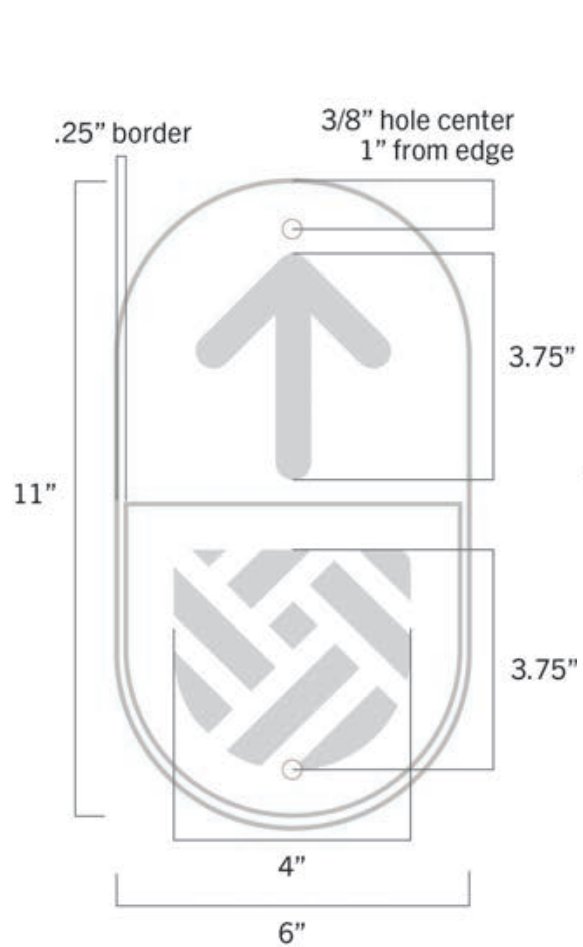

**Cyclist Intersection Route Decision Sign
(One Arrow)**

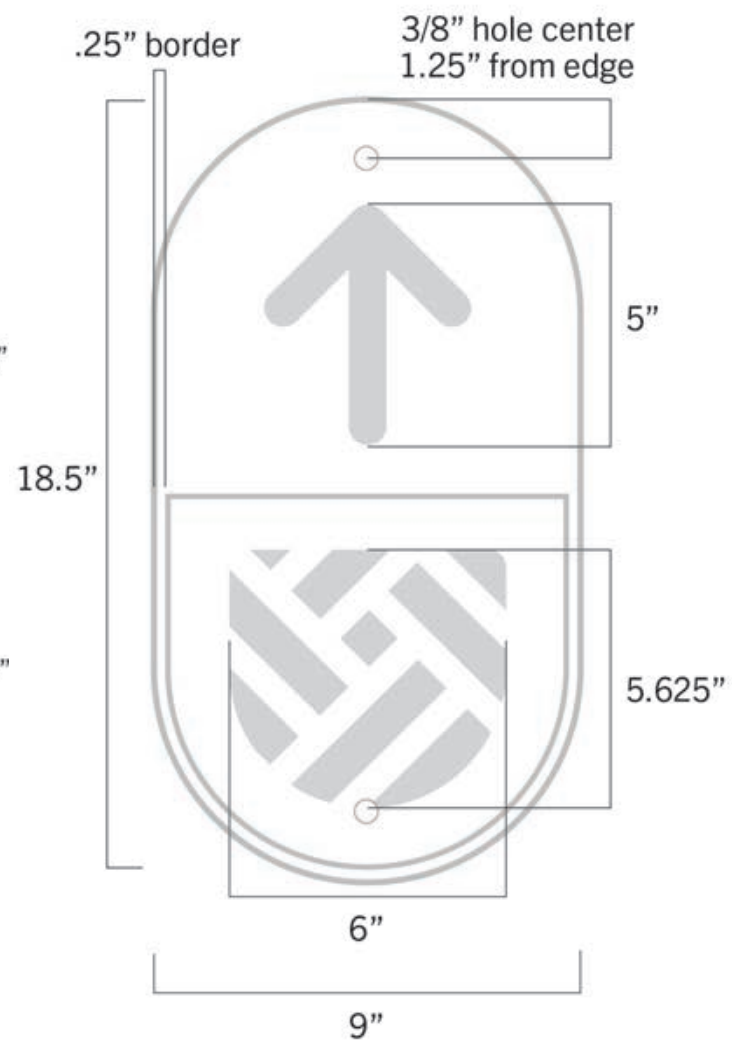

**Cyclist Intersection Route Decision Sign
(Two Arrow -Left /Right Turn)**

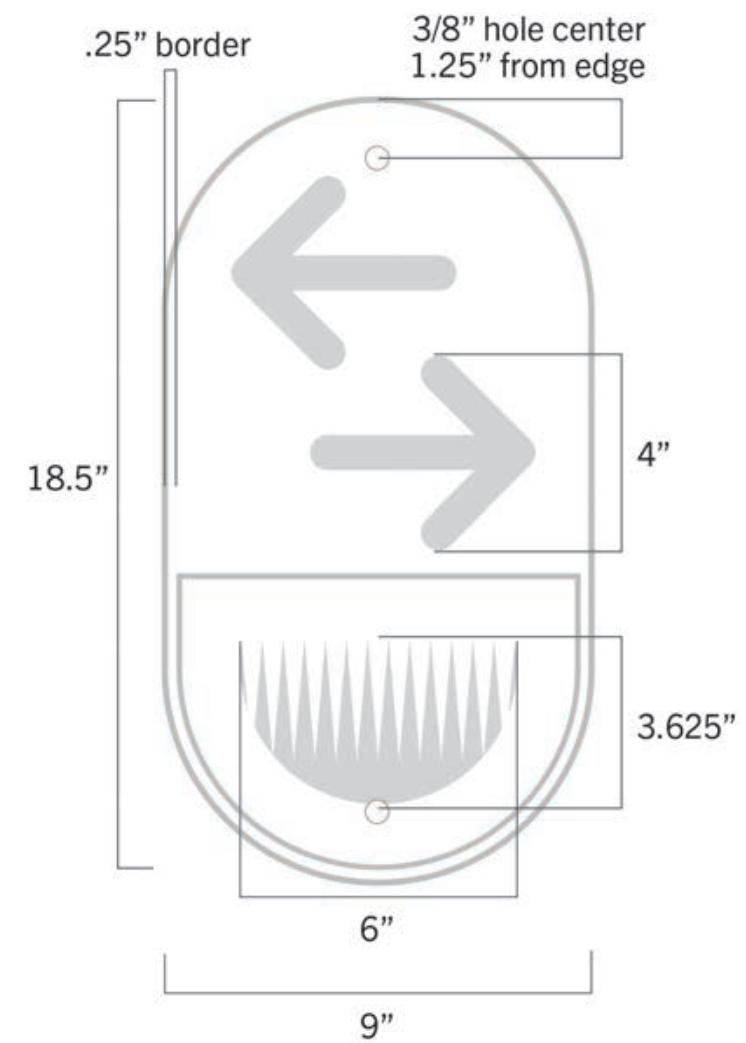

NOTE:
When left turn for a route comes before right turn, use Cyclist Intersection Route Decision Sign(Two Arrow -Right/Left Turn).

Cyclist Decision Sign with Route Color Confirmation Band



Cyclist Decision Wrap with Route Color Confirmation Band



Stacked Cyclist Decision Sign with Separate Route Color Confirmation Sign

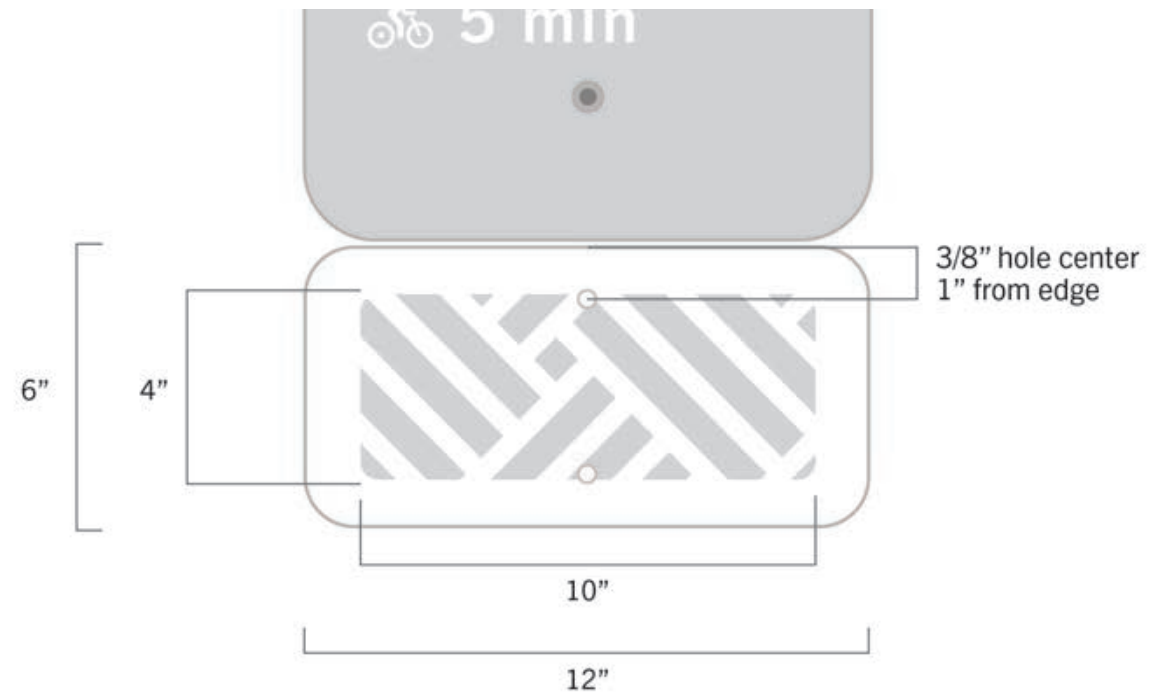

Cyclist Street Sign with Separate Route Color Confirmation Sign

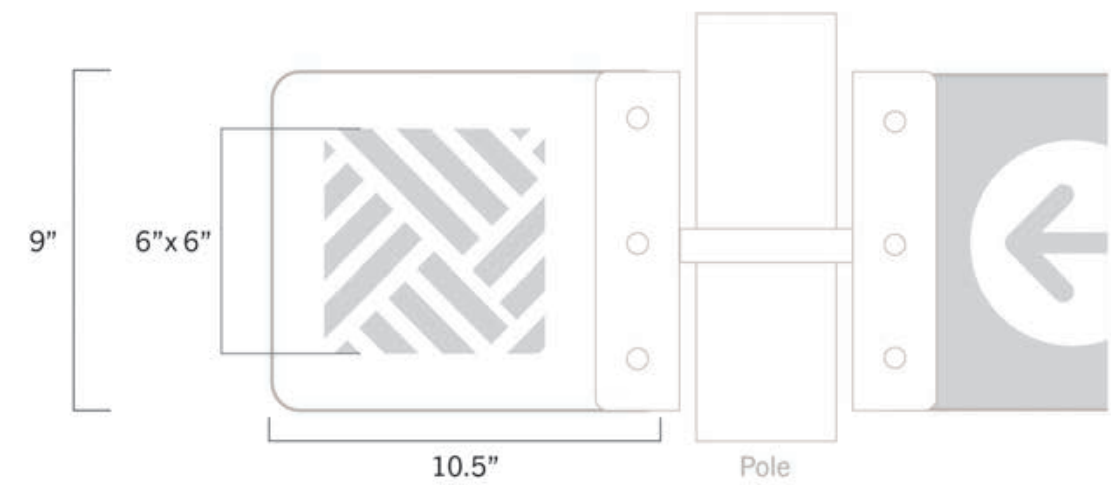

Cyclist Route Color Confirmation Sign with Cyclist Icon

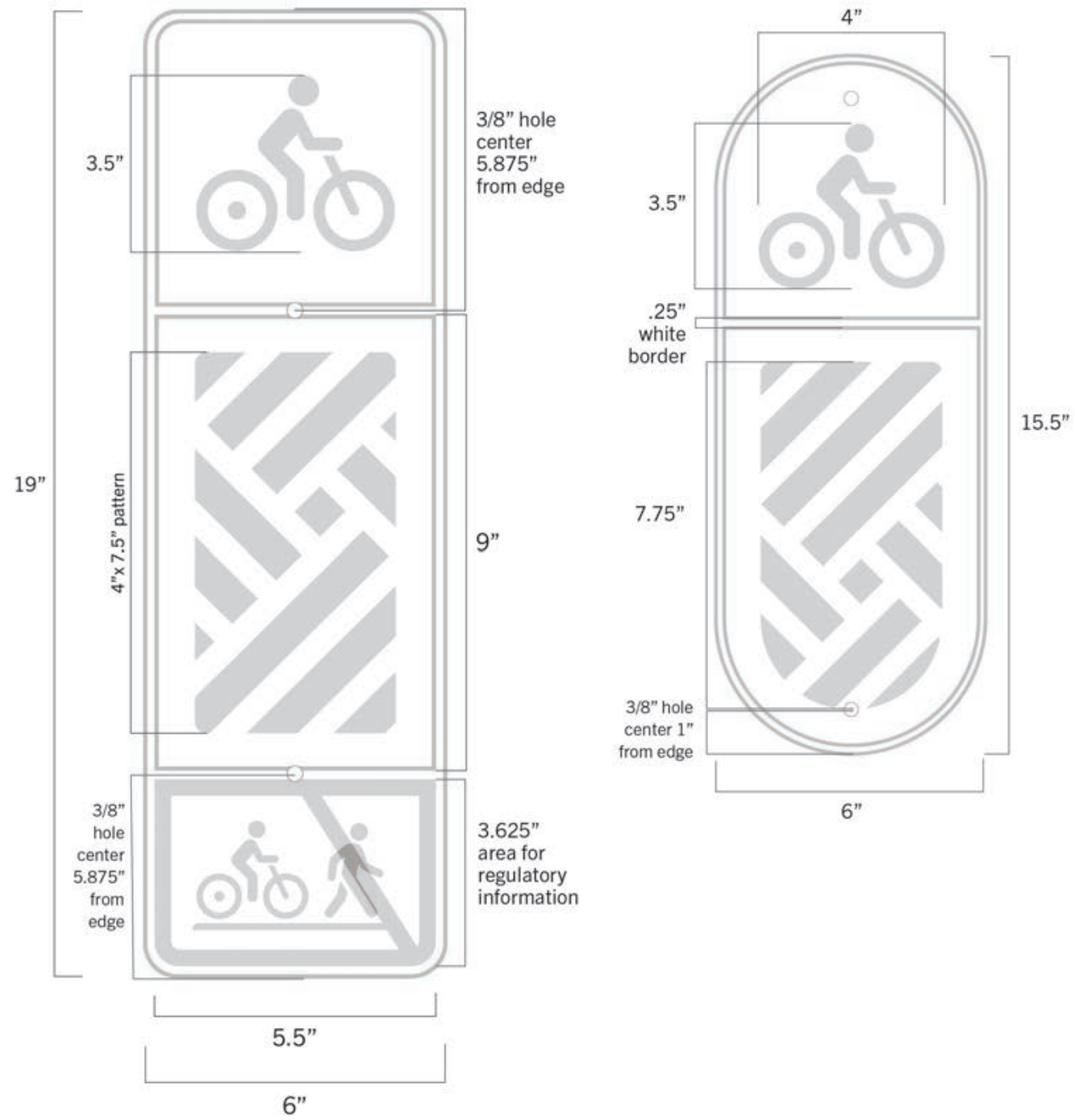

Bicycle Lafayette Totems and Map Signs



NOTE:
Totems/map sign sizes and design will vary depending on location.

Construction documents for totem fabrication can be found in Route Lafayette.

Works Cited

Chapter 1

- Clos, Joan and London School of Economics. "Urban Pragmatics." *Shaping Cities in an Urban Age*. Phaidon. 25-26.
- Florida, Richard. "US Millennials Really Do Prefer Cities." *Bloomberg News* 28 May 2019. <https://www.bloomberg.com/news/articles/2019-05-28/u-s-millennials-really-do-prefer-cities>
- Götschi T, Garrard J, Giles-Corti B. "Cycling as a part of daily life: a review of health perspectives." *Transp Rev* 2016.
- Kent, Alexander J. "When Topology Trumped Topography: Celebrating 90 Years of Beck's Underground Map". *The Cartographic Journal* 1 February 2021. 58: 1–12 – via Taylor & Francis.
- "Lafayette, Louisiana." Map. *Tree Equity Score* 15 Feb. 2022 <<https://treeequityscore.org/map/#11/30.2008/-92.0443>>.
- "Lafayette, Louisiana." Map. *Walkscore* 15 Feb. 2022 < <https://www.walkscore.com/LA/Lafayette>>.
- Lynch, Kevin. *Images of the City*. Cambridge, Massachusetts: The MIT Press, 1960. 46-90.
- Mader, Christiaan. "Struggling Louisiana Neighborhood Sees New Highway as a Perilous Exit." *New York Times* 15 Apr. 2022.
- Studer, Quint. Lecture. "Vibrant Community Talk." Acadiana Center for the Arts, Lafayette, Louisiana. 17 June 2021.
- "Volume 5B: Implementation – Green Loop." City of Portland 1 Feb. 2021 <<https://www.portland.gov/bps/planning/green-loop>>.

Images

- "13th Avenue Protected Bikeway: 2020." Photograph 2020. City of Eugene. <<https://www.eugene-or.gov/3742/13th-Avenue-Protected-Bikeway-2020>>.
- "Oosterspoorbaan." Photograph. OKRA Landschapsarchitecten. < <https://www.okra.nl/en/projects/oosterspoorbaanpark/>>.
- Pare Corporation. "Curb Separation." Photograph 2018. *The Misquamicut Bike Path Feasibility Study, City of Westerly*. < <https://westerlyri.gov/DocumentCenter/View/5749/Misquamicut-Bike-Path-Feasibility-Study-Final>>.
- "Poudre Learning Center." Photograph 2014. *Greeley Tribune*. <<https://www.greeleytribune.com/2018/07/20/massive-northern-colorado-water-supply-project-hits-major-milestone-with-army-corps-environmental-impact-statement/>>.
- "Seventh Avenue." Photograph. *Hazelwood Green*. <<https://www.hazelwoodgreen.com/protected-bicycle-lanes/fbozbmo9sziksk7oypwlosantzo5c7>>.

Chapter 2

- Traffic Engineering Handbook, Sixth Edition*. Institute of Transportation Engineers. Washington, DC, 2009. 128-130.

Chapter 5

- Traffic Engineering Handbook, Sixth Edition*. Institute of Transportation Engineers. Washington, DC, 2009. 128-130.

Images

- "Acadiana Park Nature Station." Photograph. *MapsUS*. <<https://mapsus.net/US/acadiana-park-nature-station-3993812>>.
- "Acadiana Superette." Photograph 2022. Instagram. <<https://www.instagram.com/p/CbAUVOLuBu5/>>.
- "Beaver Park." Photograph. Lafayette Consolidated Government. <<https://www.lafayettela.gov/ParksRecreation/parks/beaver-park>>.
- "Beaver Park-Lafayette, Louisiana." Photograph. *Top Brunch Spots*. <<https://topbrunchspots.com/attractions/beaver-park-lafayette-louisiana/>>.
- Bergeron, Megan. "Lafayette Strong Pavilion." Photograh 2016. *Architect Magazine*. <https://www.architectmagazine.com/project-gallery/lafayette-strong-pavilion_o>.
- "City Park." Photograph. Lafayette Consolidated Government. <<https://www.lafayettela.gov/ParksRecreation/parks/city-park>>.
- Clause, Scott. "Kirk's U Needs Butcher Customer Appreciation Day for the dedication of the McComb-Veazey Neighborhood Coterie first Local Legends Wall." Photograph 2016. *The Daily Advertiser*. <<https://www.theadvertiser.com/story/news/local/2016/05/25/coterie-dedicates-mural-local-legends/84910840/>>.
- "David Thibodaux STEM Magnet Academy." Photograph. Stem School. <<https://www.stemschool.com/school/david-thibodaux-stem-magnet-academy>>.
- DeHart, Allison. "Making Noise in Quiet Town." Photograph 2019. *The Current*. <<https://thecurrentla.com/2019/making-noise-in-quiet-town/>>.
- "Downtown Lafayette." Photograph. Deb and Dave RV Adventures. <https://debdavervadventure.webstarts.com/the_south_5-1-12>.
- Durio, Kate. "Freetown-Port Rico." Photograph 15 Mar. 2017. *The Daily Advertiser*. <<https://www.theadvertiser.com/story/entertainment/2017/03/15/freetown-port-rico-what-makes-neighborhood-so-special/98199194/>>.
- "Early College Academy." Photograph 2021. KATC. <<https://www.katc.com/news/lafayette-parish/eca-ranks-highest-scoring-school-in-louisiana>>.
- "The Edge At Lafayette Apartments." Photograph. Rate My Apartment. <<https://www.ratemyapartments.com/ratings/la/south-louisiana-community-college/the-edge-at-lafayette-apartments-2281132>>.
- Ferguson, Nathan. "Cajundome" Photograph 2012. Four Square. <<https://foursquare.com/cajundome?openPhotold=5078a408e4b00eb860c52d2c>>.
- Gaspard, Derek & Dustin. "Bendel Gardens." Photograph 13 Sept 2018. *The Daily Advertiser*. <<https://www.theadvertiser.com/story/life/luxury-living/2018/09/13/got-2-m-see-what-you-can-get-bendel-gardens/1258897002/>>.
- "Girard Park." Photograph. Lafayette Consolidated Government. <<https://www.lafayettela.gov/ParksRecreation/default>>.
- "Heymann Memorial Park." Photograph. MapsUS. <<https://mapsus.net/US/heyman-memorial-park-3300378>>.
- "Heymann Park." Photograph. Lafayette Consolidated Government. <<https://www.lafayettela.gov/ParksRecreation/parks/heyman-park>>.
- "J. W. Faulk." Photograph. Lafayette Public School System. <<https://www.lpssonline.com/schools/jw-faulk>>.
- "Life Storage Lafayette." Photograph. Life Storage. <<https://www.lifestorage.com/storage-units/louisiana/lafayette/>>.
- "Louisiana Immersive Technologies Enterprise." Photograph 2007. Beazley Moliere. <<https://beazleymoliere.com/project/lite/>>.
- May, Robin. "McComb Veazey Community House." Photograph 2019. *The Acadiana Advocate*. <https://www.theadvocate.com/acadiana/multimedia/photos/collection_7f222768-abfb-11e9-a821-77c2b51f1a13.html#1>.

- McCullough, Brian. "M&S Grocery." Photograph 2011. Four Square. <<https://foursquare.com/v/ms-grocery/436899f964a520a76625e3?openPhotoid=4ddc2446fd281723a4235a6b>>.
- "Moncus Park." Photograph 2021. Moncus Park. <<https://moncuspark.org/national-landscape-industry-recognizes-moncus-park/>>.
- "Mouton Plantation in Lafayette, La," Photograph 2020. The Beth List. <<https://www.thebethlists.com/90-notable-nights/250-mouton-plantation-in-lafayette-la>>.
- "Ochsner Lafayette General." Photograph 2019. Ochsner Lafayette General. <<https://ochsnerlg.org/about-us/news/level-ii-trauma-center>>.
- "Park Tower Building." Photograph. Rault Resources Group. <<https://raultgroup.com>>.
- Peck, James. "LJ Alleman." Photograph. The Pixel House. <<https://acswarchitects.com/project/l-j-alleman-middle-school-cafeteria-classroom-addition/>>.
- "River Ranch." Photograph. Apartments.com. <<https://www.apartments.com/mainstreet-at-river-ranch-lafayette-la/7fvn1zy/>>.
- Spatms. "Cajun Field (Lafayette, Louisiana)." Photograph 2018. Wikipedia. <https://en.m.wikipedia.org/wiki/File:Cajun_Field_%28Lafayette,_Louisiana%29.jpg>.
- "St. Leo the Great." Photograph. Mapio. <<https://mapio.net/pic/p-24356899/>>.
- "T-Coon's Restaurant." Photograph 2016. Google. <<https://www.google.com/maps/uv?pb=!1s0x86249d1dbecb94eb%3A0xa31a1a4be842533c!3m1!7e115!4shttps%3A%2F%2Fh5.googleusercontent.com%2Fp%2FAF1QipOmQafNt4NZwXiZwWW5CDVNia8yI4y94wkWxPmm%3Dw426-h320-k-no!5st-coons%20lafayette%20la%20-%20Google%20Search!15sCgIQAQ&imagekey=!1e10!2sAF1QipOmQafNt4NZwXiZwWW5CDVNia8yI4y94wkWxPmm&hl=en&sa=X&ved=2ahUKEwjQsZPA8Kr4AhUKmGoFHcKSDc8Qoip6BAhREAM>>.
- The DL Guy. "Caroline and Company-River Ranch Location." Photograph 2020. <<https://developinglafayette.com/wp/inside-of-caroline-companys-new-river-ranch-location/>>.
- The DL Guy. "Lafayette Regional Airport." Photograph 2021. Developing Lafayette. <<https://developinglafayette.com/wp/inside-look-at-the-new-lft-terminal-opening-january-2022/>>.
- The DL Guy. "SLCC Health and Science Building." Photograph 2017. Developing Lafayette. <<https://developinglafayette.com/wp/slccs-health-sciences-building-is-complete/>>.
- "Warehouse District Lofts." Photograph. PMI Integrity Properties. <<https://pmiip.cincwebaxis.com/warehousedistrict>>.
- Westbrook, Leslie. "Bottle Art Lofts." Photograph 2022. The Acadiana Advocate. <https://www.theadvocate.com/acadiana/news/business/article_63ce2160-9b22-11ec-8d7a-8b09e7afd3fb.html>.
- "Vermilionville." Photograph. Google. <https://www.google.com/maps/uv?pb=!1s0x86249cb7c7373e69%3A0xeb8441c8e9dc0790!3m1!7e115!4shttps%3A%2F%2Fh5.googleusercontent.com%2Fp%2FAF1QipOCp40pvnHijWku662BDS90JdwSFgmigGTaa7Pd%3Dw608-h320-k-no!5svermilionville%20-%20Google%20Search!15sCgIQAQ&imagekey=!1e10!2sAF1QipOCp40pvnHijWku662BDS90JdwSFgmigGTaa7Pd&hl=en&sa=X&ved=2ahUKEwjpuZvE5qr4AhU7I2oFHWMFc_oQoip6BAhWEAM>.

All other diagram images from Chapter 5 were sourced from Googlemaps.com and Zillow.com

Chapter 6

- A Policy on Geometric Design of Highways and Streets, Seventh Edition. American Association of State Highway and Transportation Officials (AASHTO). Washington, DC, 2018. 9-64 – 9-67.
- Fatality Analysis Reporting System (FARS). United States Department of Transportation (USDOT). National Highway Traffic Safety Administration, Washington, DC.
- Traffic Engineering Handbook, Sixth Edition. Institute of Transportation Engineers. Washington, DC, 2009. 128-130.
- "Using Trees and Vegetation to Reduce Heat Islands." United States Environmental Protection Agency(EPA). <<https://www.epa.gov/heatislands/using-trees-and-vegetation-reduce-heat-islands#1>>.

Images

- Cacophony. "A car of the Portland Streetcar system at the eastbound Portland State University stop, on Market Street at the South Park Blocks." Photograph 2017. Wikimedia. <<https://commons.wikimedia.org/wiki/File:PortlandStreetcar5.jpg>>.
- Carlson, Madi. "Quebec Street and 1st Avenue." Photograph 19 Feb. 2019. Bike Portland. <<https://bikeportland.org/2019/02/19/biking-through-vancouver-bcs-protected-intersection-295729>>.
- Linton, Joe. "Temple City bike lanes." Photograph 4 Jan. 2016. Streets Blog Cal. <<https://cal.streetsblog.org/2016/01/04/new-caltrans-design-bulletin-oks-protected-bike-lanes-in-ca/>>.
- Pinder, Matt. "Ottawa Intersection." Photograph 6 Dec. 2021. Beyond the Automobile. <<https://beyondtheautomobile.com/2021/12/06/this-intersection-design-will-save-lives/>>.
- "Riders on horseback for a leisurely tour of Bogue Chitto State Park." Photograph. Heart of Louisiana. <<https://heartoflouisiana.com/horse-trail-ride>>.

Chapter 8

Images

- "Pontiac Point Park." Photograph 2019. Facebook. <<https://www.facebook.com/celebratedapoint/photos/a.2259994577655188/2382571502064161/>>.

Chapter 9

- "Bike Route Wayfinding Signage and Markings System." National Association of City Transportation Officials (NACTO). Urban Bikeway Design Guide, Second Edition. Island Press 24 Mar. 2014.
- "Figure 3B-24. Examples of Standard Arrows for Pavement Markings." The Manual on Uniform Traffic Control Devices (MUTCD). 2009. Revised ed., Federal Highway Administrator, 2012. 809.
- "Figure 9C-3. Word, Symbol, and Arrow Pavement Markings for Bicycle Lanes." The Manual on Uniform Traffic Control Devices (MUTCD). 2009. Revised ed., Federal Highway Administrator, 2012. 388.
- "What is Wayfinding?" Society for Experiential Graphic Design (SEGD). <<https://segd.org/what-wayfinding>>.

